

Container shelter/ Containerüberdachung / Abris sur containers

KROFTMAN CT-S-1206 / 1212

Assembly manual for main cover

Montageanleitung für die Hauptabdeckung

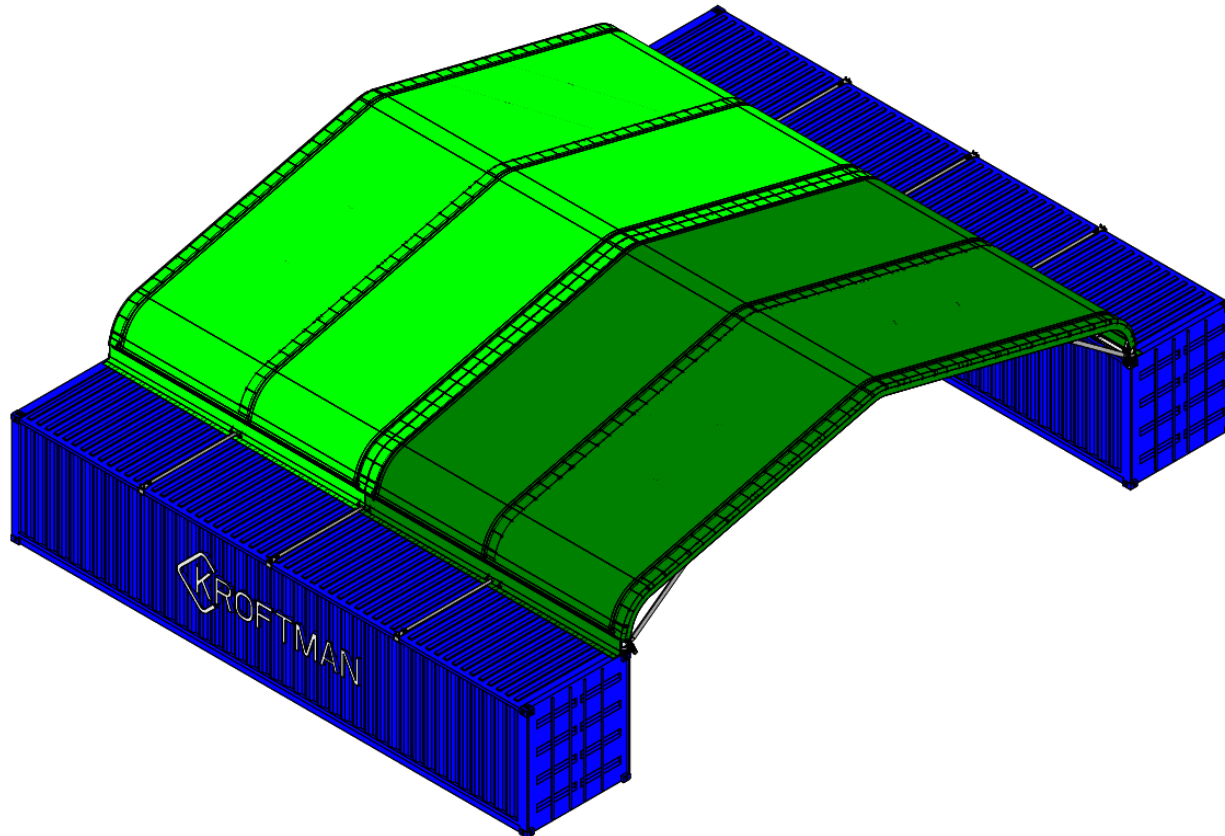

Manuel d'assemblage du couvercle principal

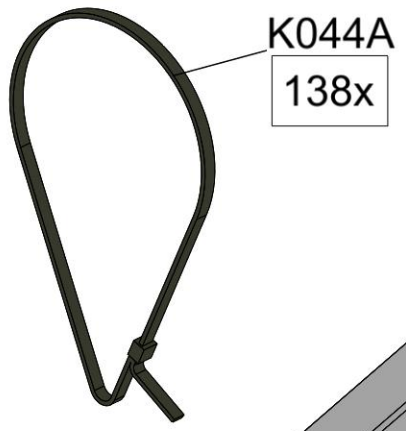







K044A
138x

41 1x

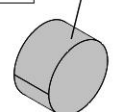

 2x set for CT-S-1212
 2x Set für CT-S-1212
 2x set pour CT-S-1212

K062
6x





2x CT-S-1206/1212	K013	4x CT-S-1206/1212	K014
			
		K012	4x-CTS1206 10x-CTS1212
<p> Delivered with main frame crate  Lieferung mit Hauptrahmenkiste  Livré avec la caisse du cadre principal</p>			

CT-S-1212

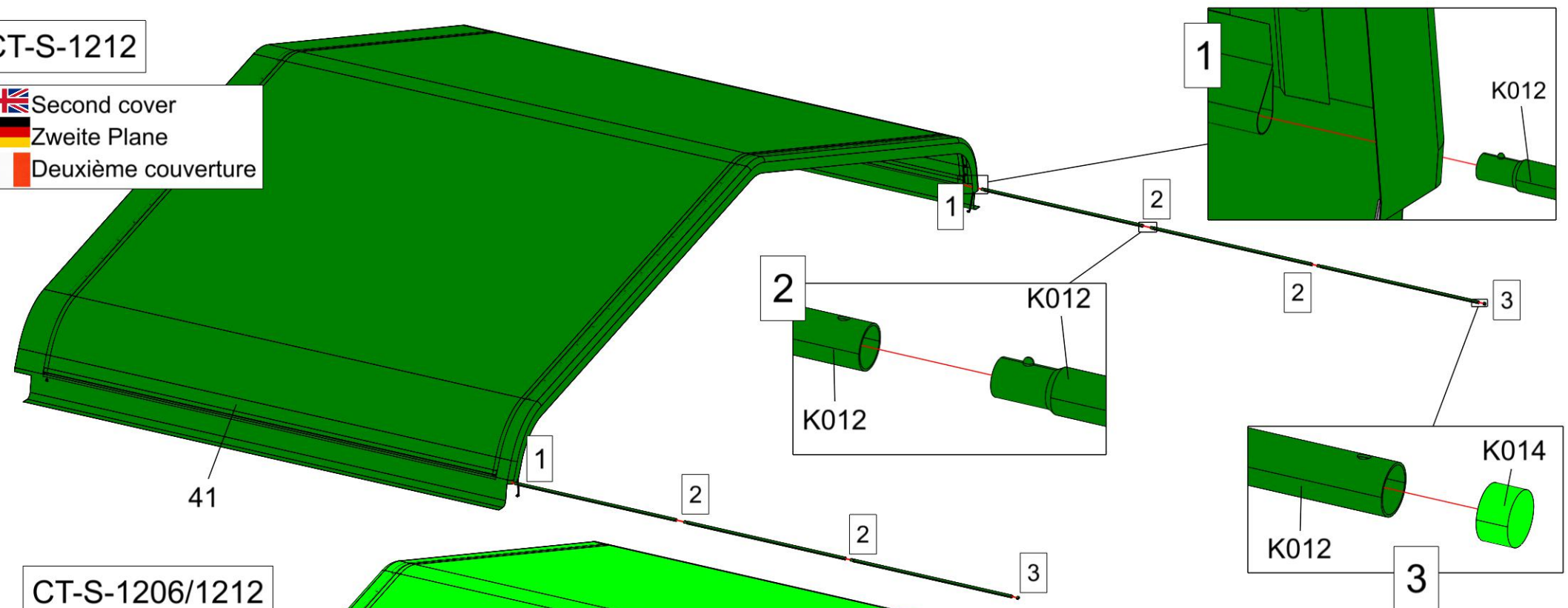

-  Second cover
-  Zweite Plane
-  Deuxième couverture



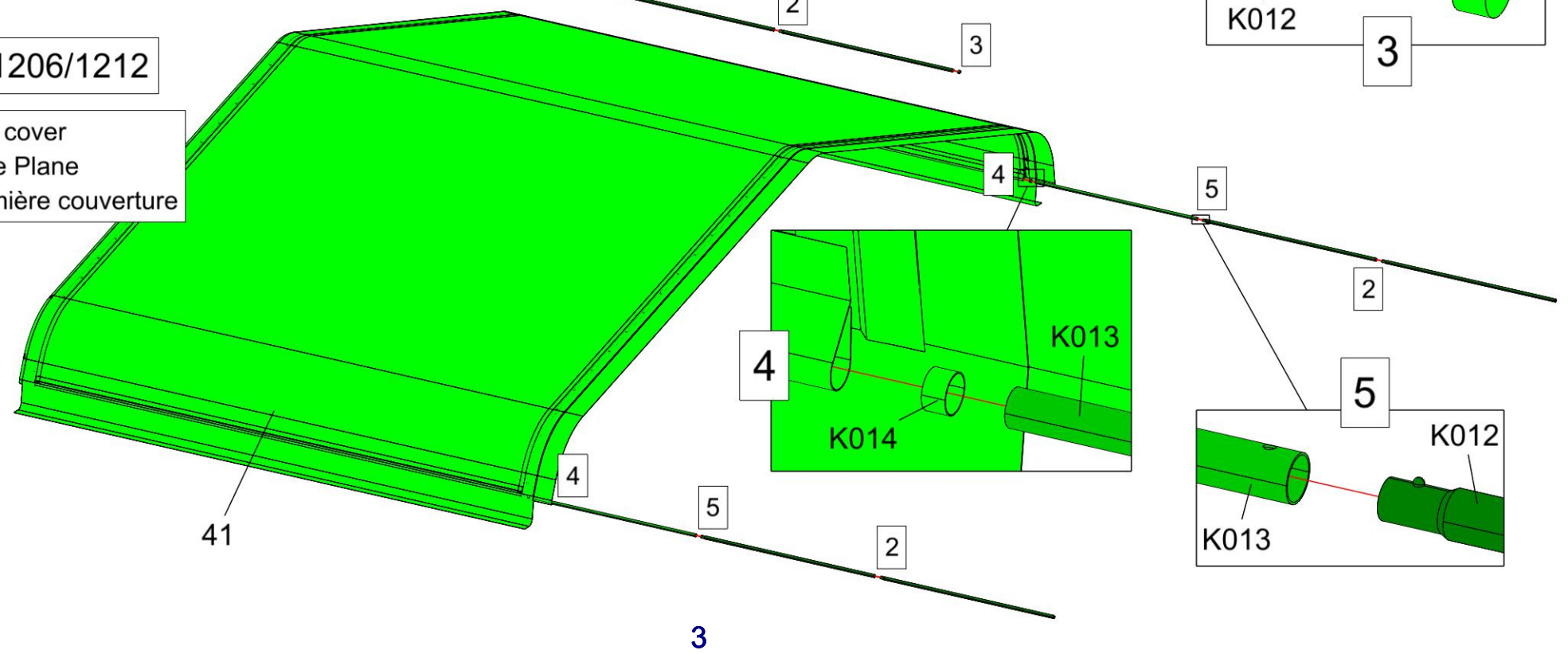

CT-S-1206/1212

-  First cover
-  Erste Plane
-  Première couverture



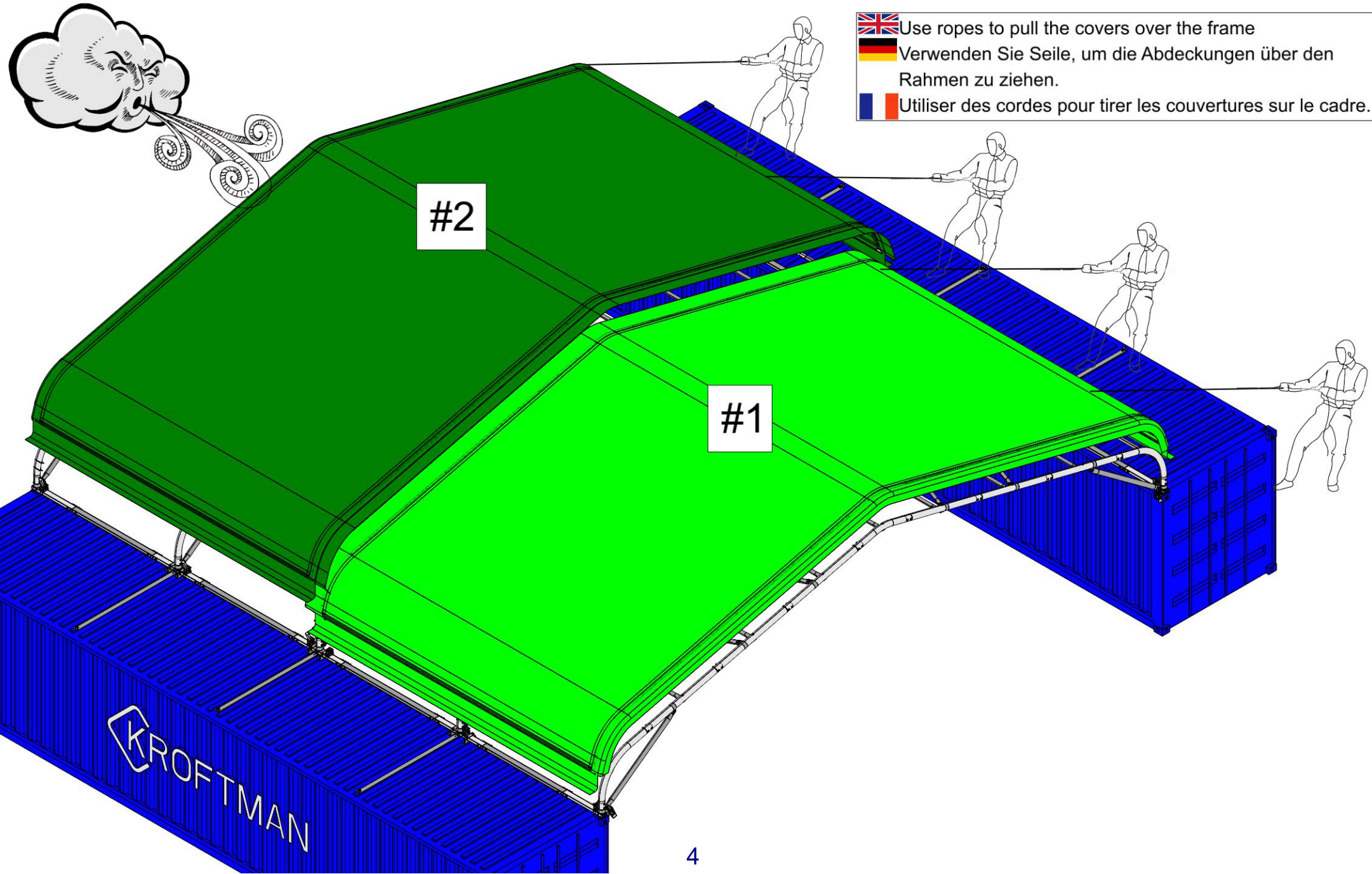

 Keep the wind direction in mind, so that water is not blown between the covers
 Beachten Sie die Windrichtung, damit kein Wasser zwischen die Planen geblasen wird.
 Gardez à l'esprit la direction du vent, afin que l'eau ne soit pas projetée entre les couvertures.

 Use ropes to pull the covers over the frame
 Verwenden Sie Seile, um die Abdeckungen über den Rahmen zu ziehen.
 Utiliser des cordes pour tirer les couvertures sur le cadre.

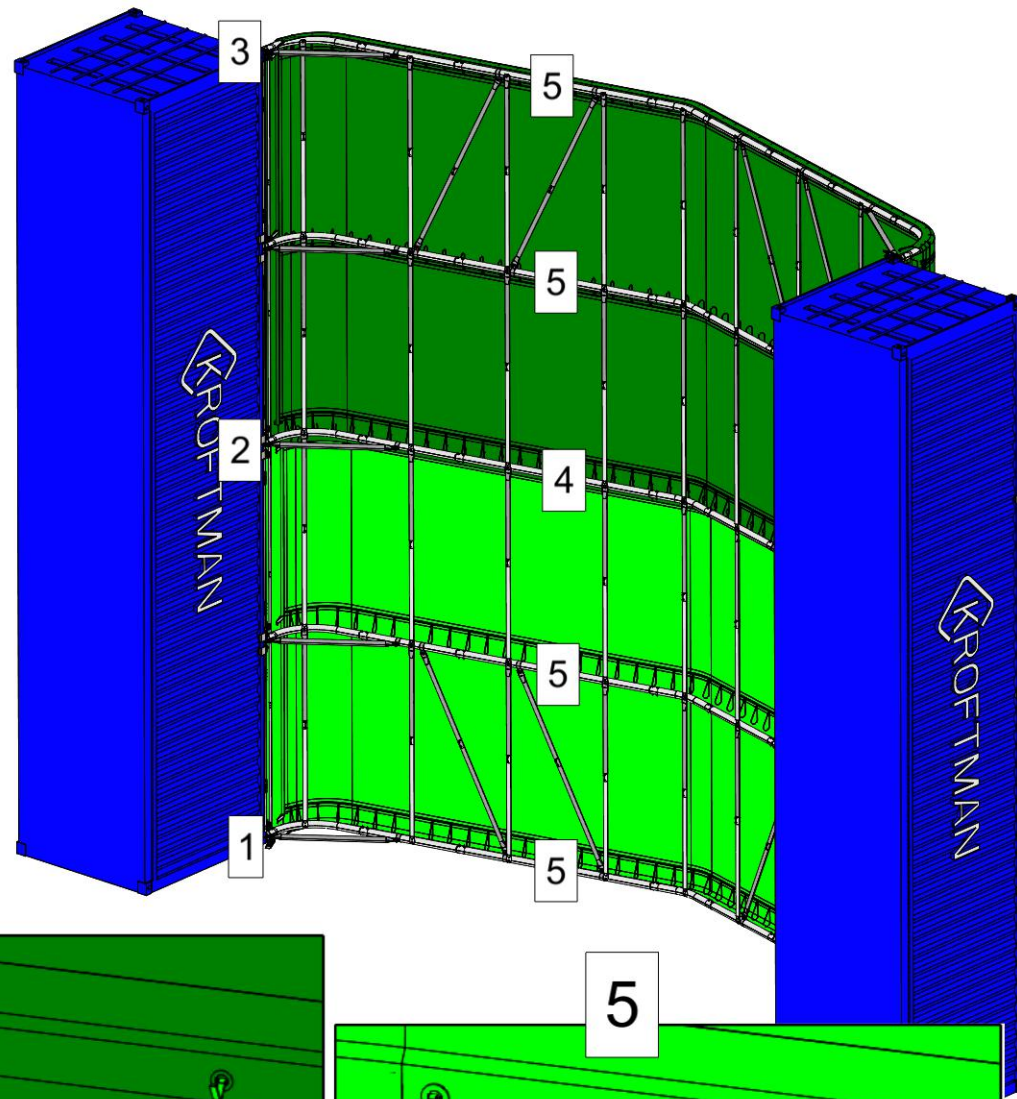
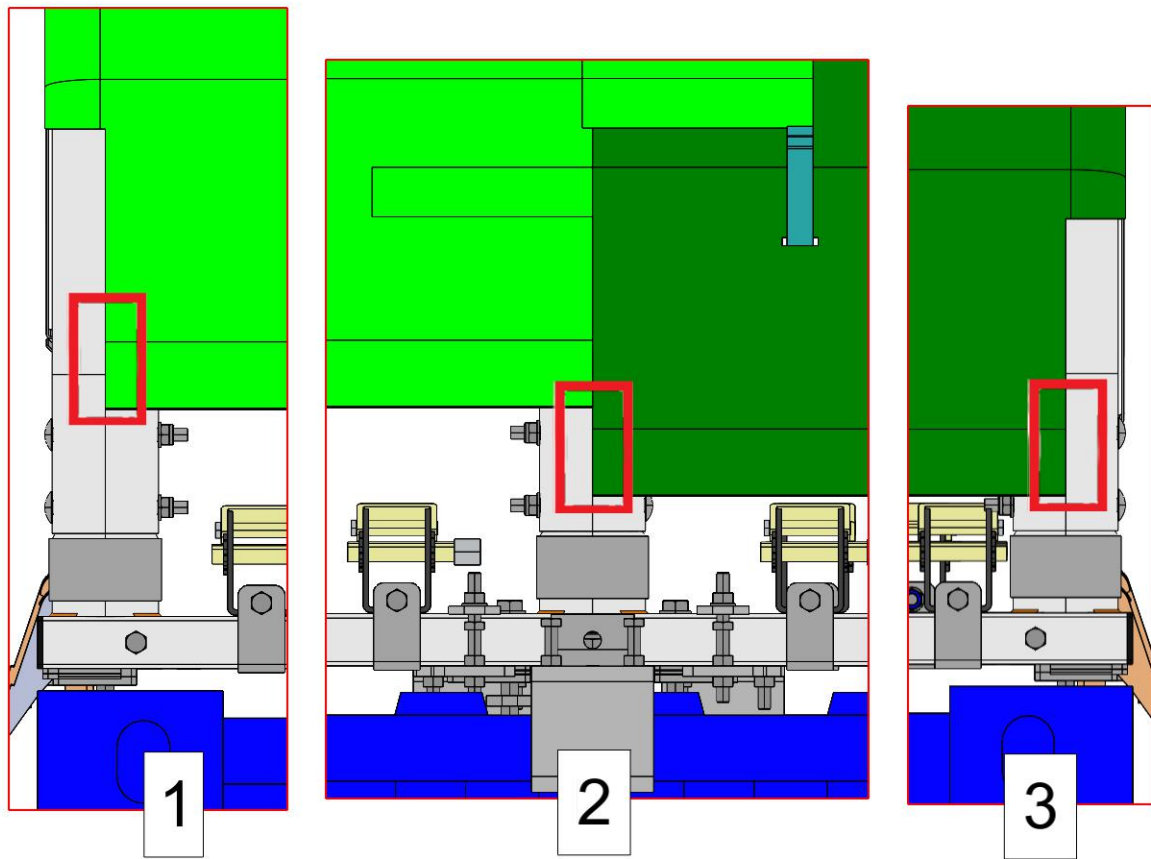





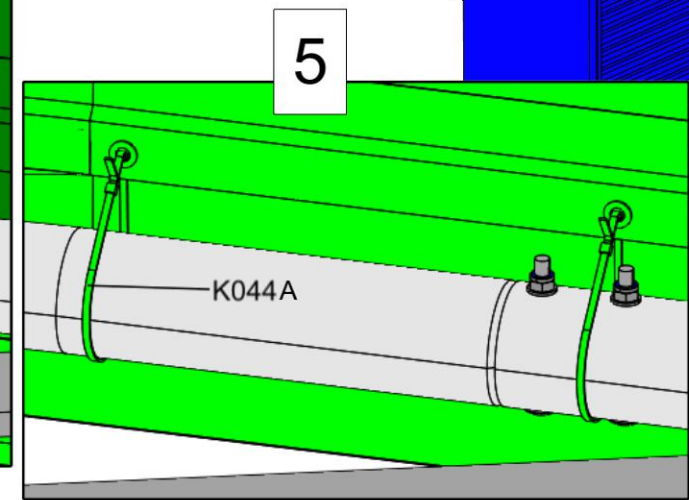
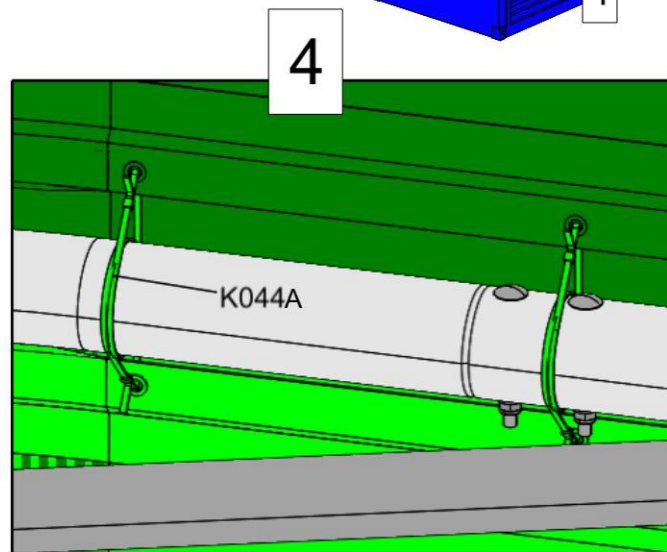

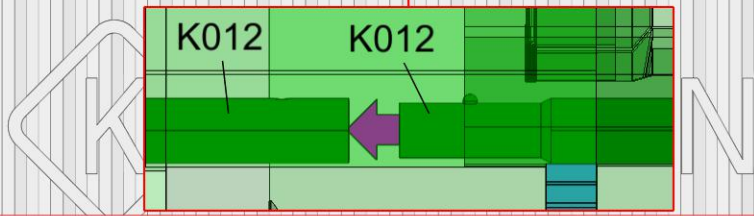
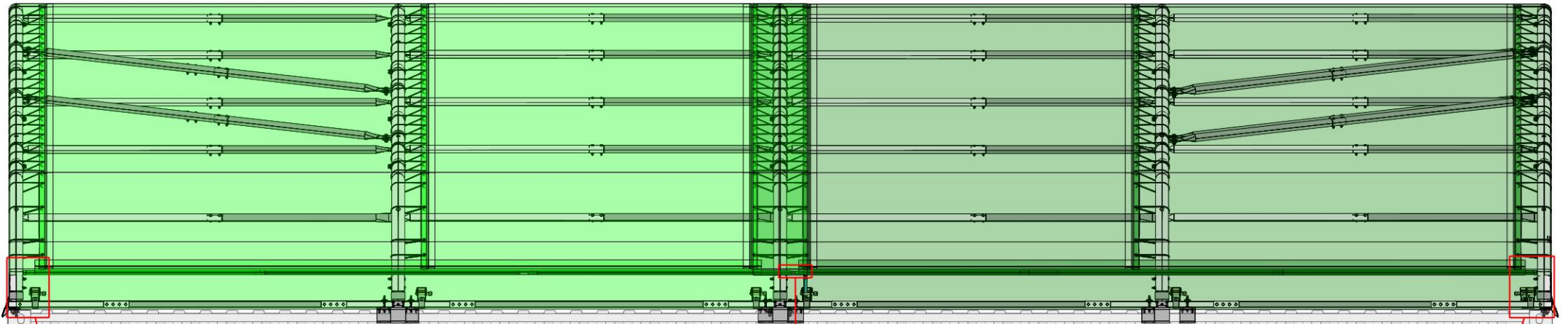

-  Make sure that the roof cover(s) are centered on the frame(s).
-  Achten Sie darauf, dass die Plane(n) in der Mitte des Dachrahmens zentriert sind.
-  Veillez à ce que le(s) couvercle(s) de toit soit(nt) centré(s) sur le(s) cadre(s).



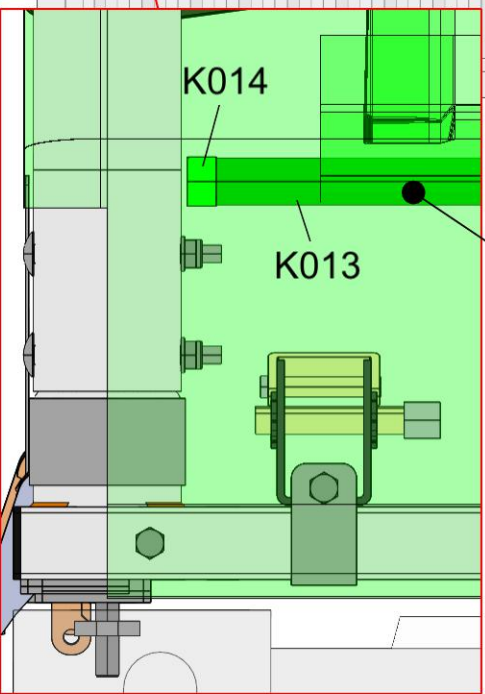



 CT-S-1212 only, connect the tubes from both covers
 Nur CT-S-1212, verbinden Sie die Schläuche von beiden Planen
 CT-S-1212 uniquement, connecter les tubes des deux couvercles



 Place the first tensioning tube (and cap) after the first arch.
 Platzieren Sie den ersten Spannröhren (und die Kappe) nach dem ersten Bogen.
 Placer le premier tube de tension (et le capuchon) après le premier arc.

 Cut the last tube so that it ends before the last arch.
 Schneiden Sie das letzte Rohr so ab, dass es vor dem letzten Bogen endet.
 Couper le dernier tube de manière à ce qu'il se termine avant le dernier arc.

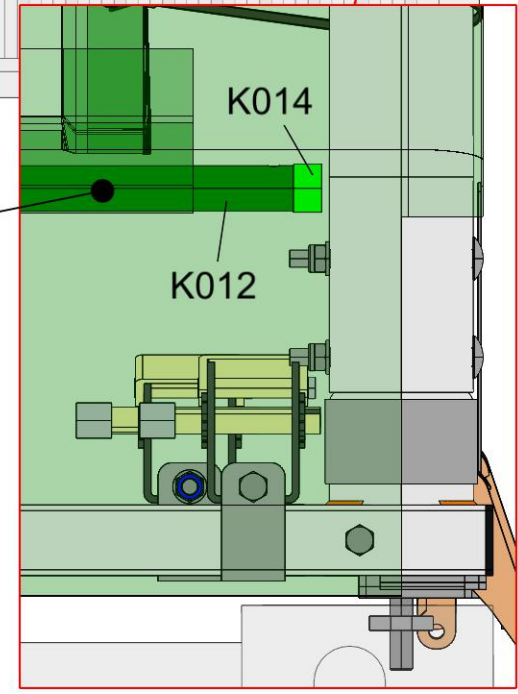

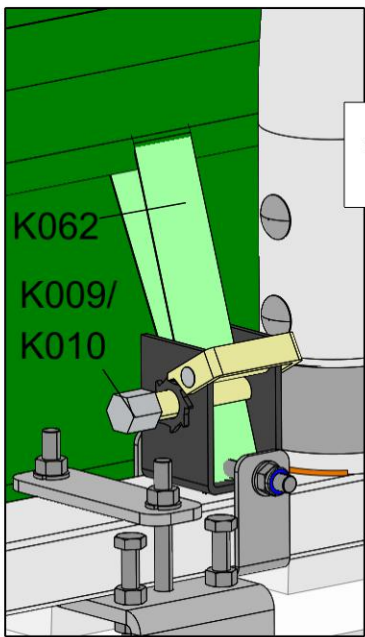



1

 Use the "K062" straps and the "K009", "K010" ratchets to stretch the roof cover

 Verwenden Sie die Gurte "K062" und die Ratschen "K009" und "K010", um die Dachabdeckung zu spannen.

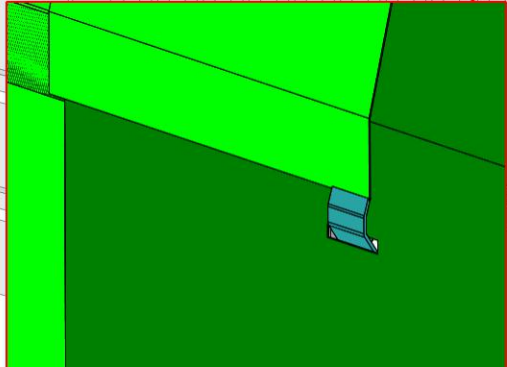
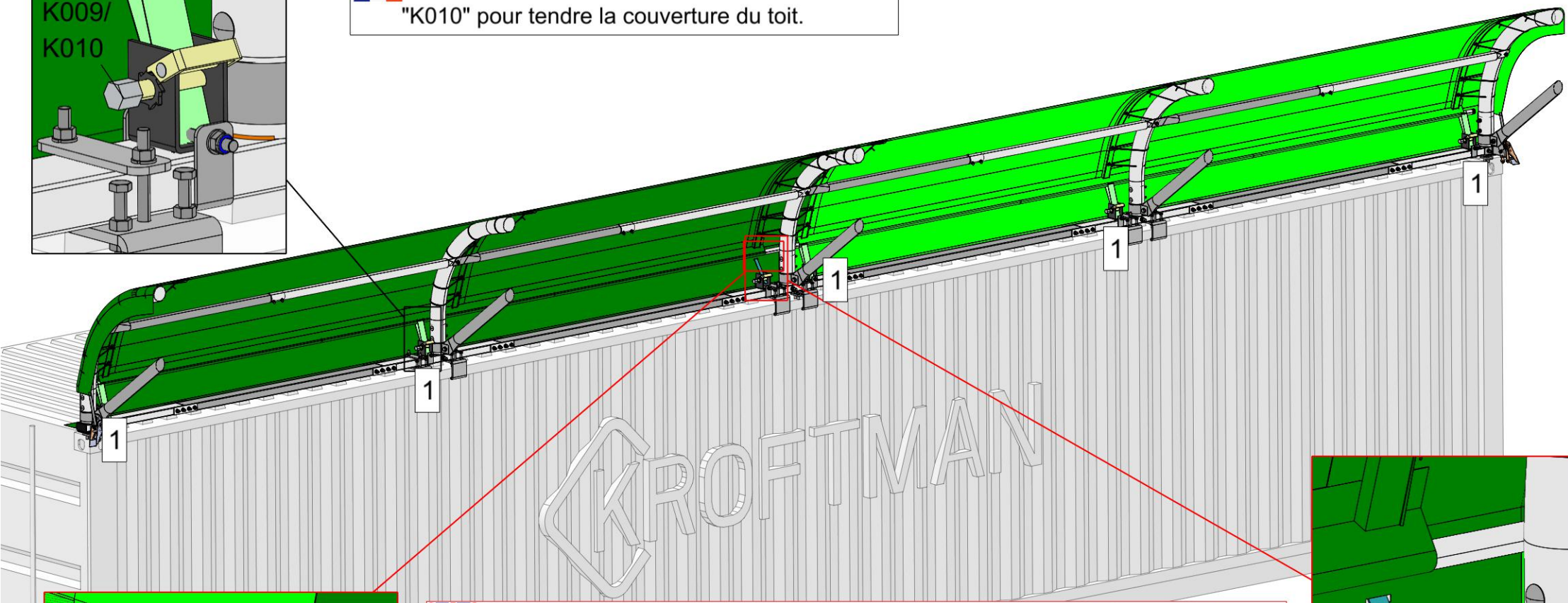
 Utiliser les sangles "K062" et les cliquets "K009", "K010" pour tendre la couverture du toit.







 CT-S-1212 only, cut a hole in the first cover, insert the strap of the second cover through it, attach the strap to the ratchet and tighten the strap

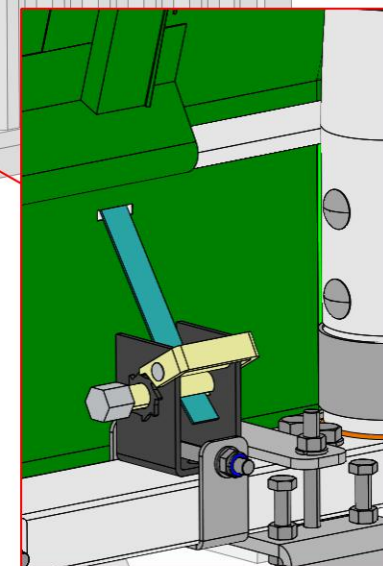

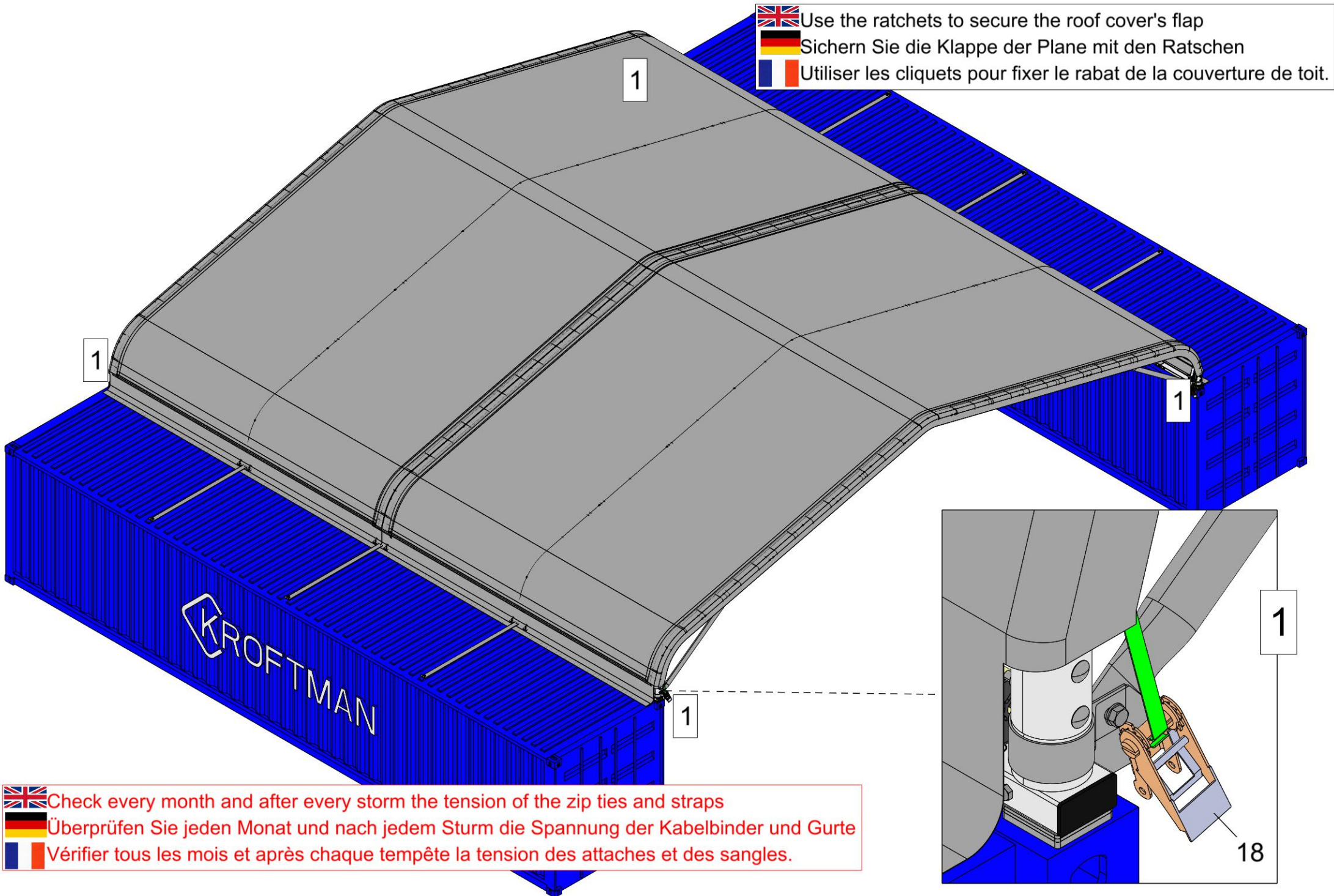
 Nur CT-S-1212, schneiden Sie ein Loch in die erste Plane, führen Sie den Gurt der zweiten Plane hindurch, befestigen Sie den Gurt an der Ratsche und ziehen Sie den Gurt fest.

 CT-S-1212 uniquement, découpez un trou dans la première couverture, insérez la sangle de la deuxième couverture à travers cetrou, attachez la sangle au cliquet et serrez la sangle.





 Use the ratchets to secure the roof cover's flap
 Sichern Sie die Klappe der Plane mit den Ratschen
 Utiliser les cliquets pour fixer le rabat de la couverture de toit.

 Check every month and after every storm the tension of the zip ties and straps
 Überprüfen Sie jeden Monat und nach jedem Sturm die Spannung der Kabelbinder und Gurte
 Vérifier tous les mois et après chaque tempête la tension des attaches et des sangles.