

FRONT WALL

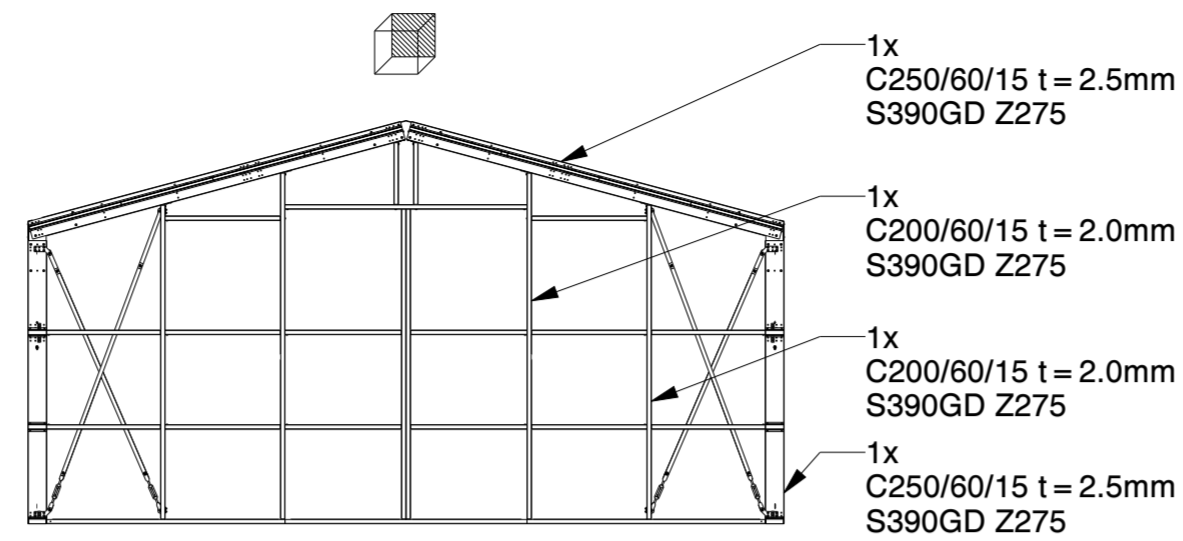

BACK WALL

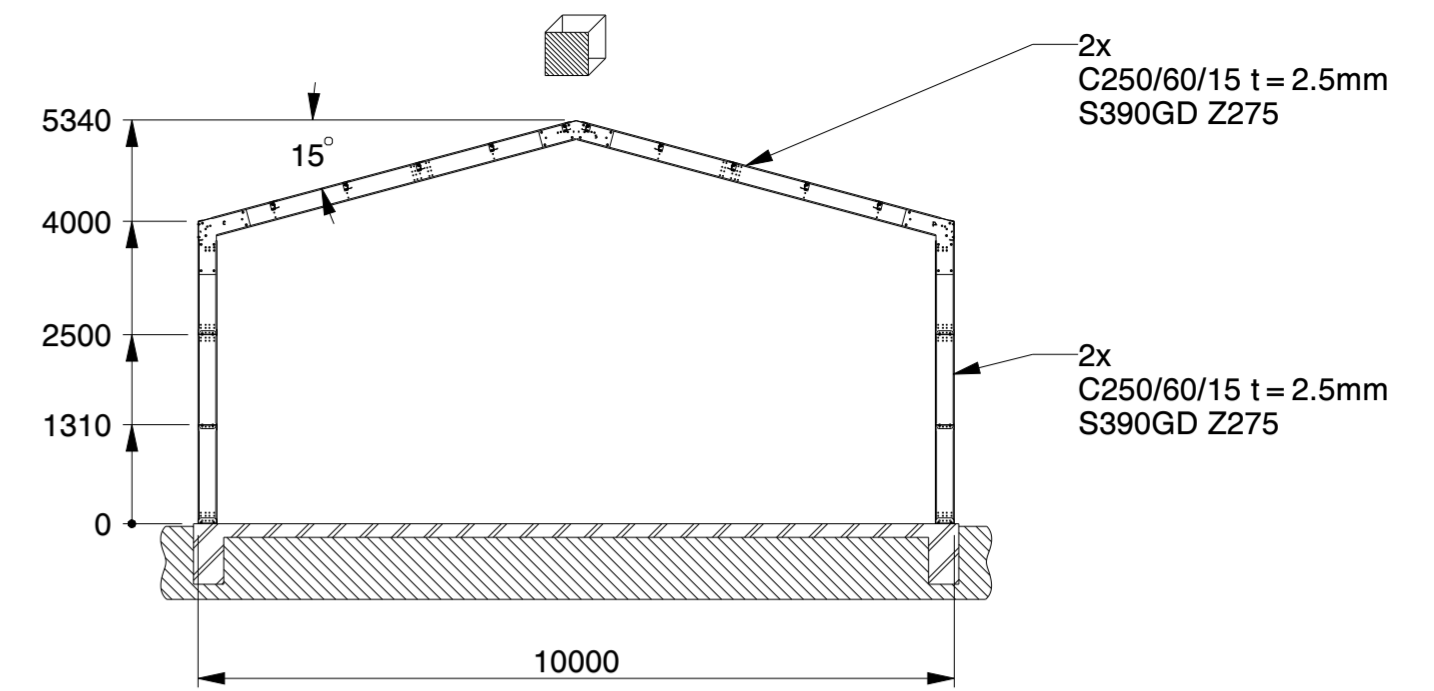

SECTION B-B

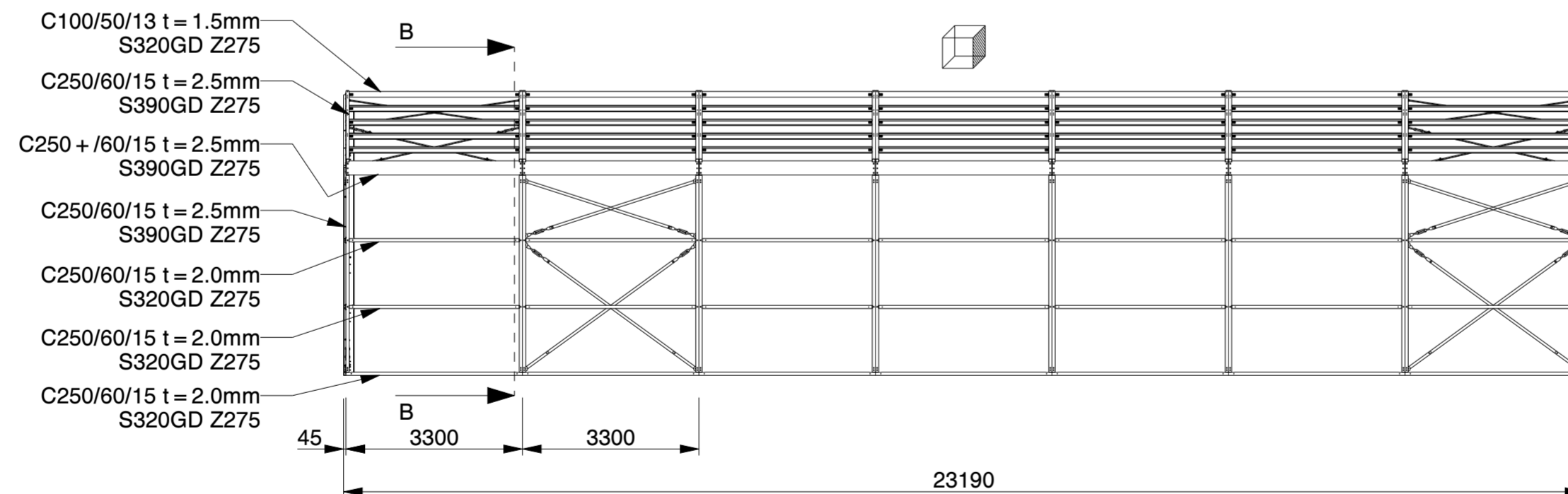
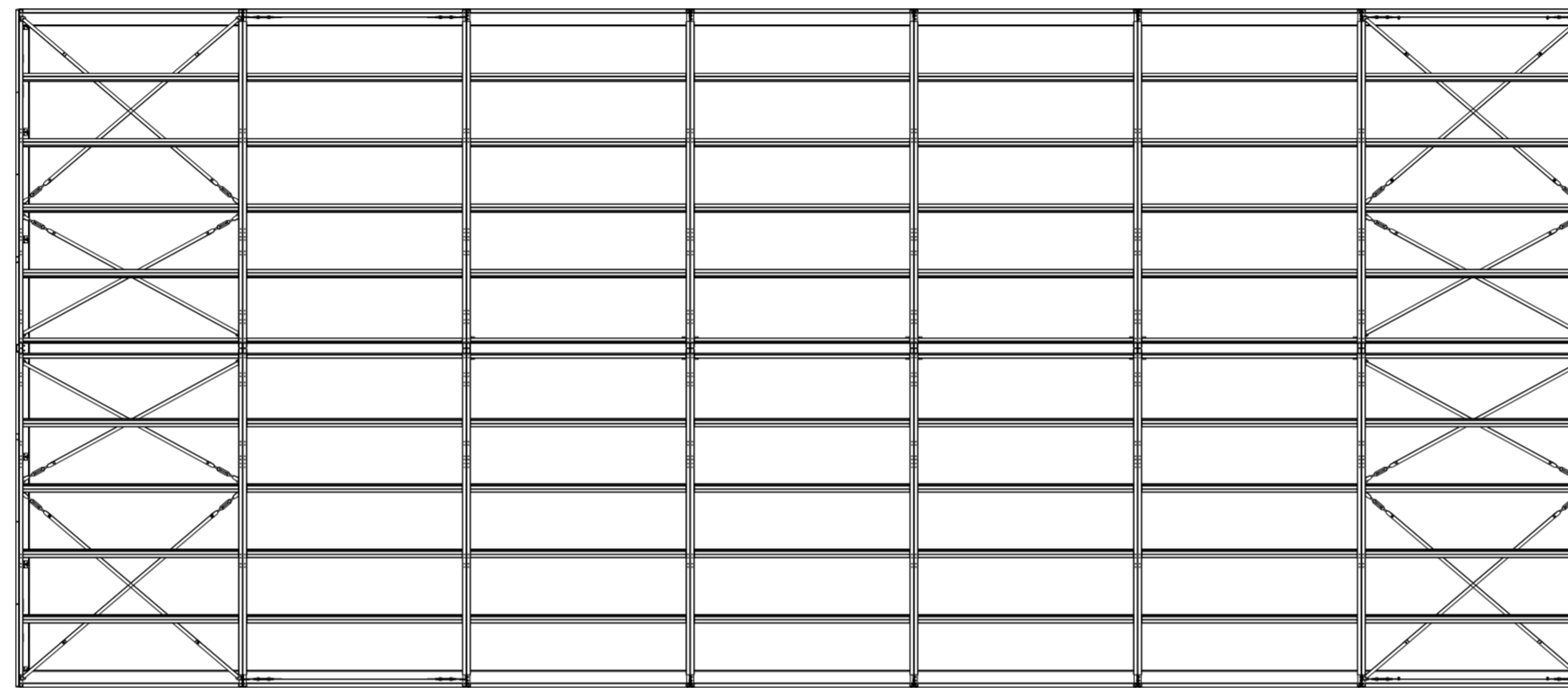

Genehmigung / Approval / Goedkeuring	
Kundenname: Client name: Klantnaam:	Firmenstempel: Company stamp: Firmastempel:
Datum: Date: Datum:	
Unterschrift: Signature: Handtekening:	

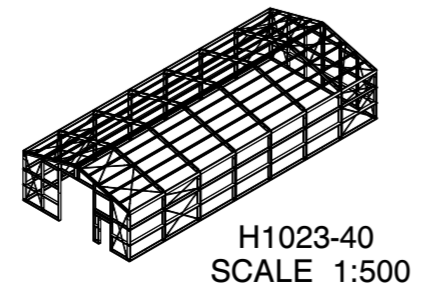

NET USABLE AREA:  
216.5 M2 (APPROX. 22.7 M X 9.5 M)

<b>KROFTMAN</b>	LASERCUT ACCORDING: EN-ISO 9013-5-4-1		MATERIAL: See List	
	MATERIAL CERTIFICATE: 3.1 (OR 2.2 WHEN S235JR)		TREATMENT:	
	GALVANIZING ACCORDING: EN ISO 1461		STATUS: Released	
	BEND RADIUS UNLESS DEFINED R <sub>i</sub> =t			
TOLERANCES UNLESS OTHERWISE SPECIFIED:				
GENERAL ROUGHNESS R <sub>a</sub> ✓	DIMENSION: ±	ANGLE: ±°	MODEL NUMBER LCA00059	REVISION: 3
DESCRIPTION: Lagerhalle / Storage Building / Opslagloods H1023-40 Frame only				
SCALE: 1:100	UNITS: mm	PROJECTION: FIRST ANGLE	MODIFIED ON: 01-09-2023 MODIFIED BY: AVA	APPROVED ON: 01-09-2023 APPROVED BY: BVB
		MASS: 5927,6 kg	Sheet 1 of 1	Size: A2
© KROFTMAN STRUCTURES B.V. Duplication and copying without written permission of the owner is prohibited				

DRAWING NAME: LCA00059\_STRUCTURE