

Container shelter/ Containerüberdachung / Abris sur containers



KROFTMAN CT-A-800

Assembly manual for end wall cover

Montageanleitung für Stirnwandabdeckung

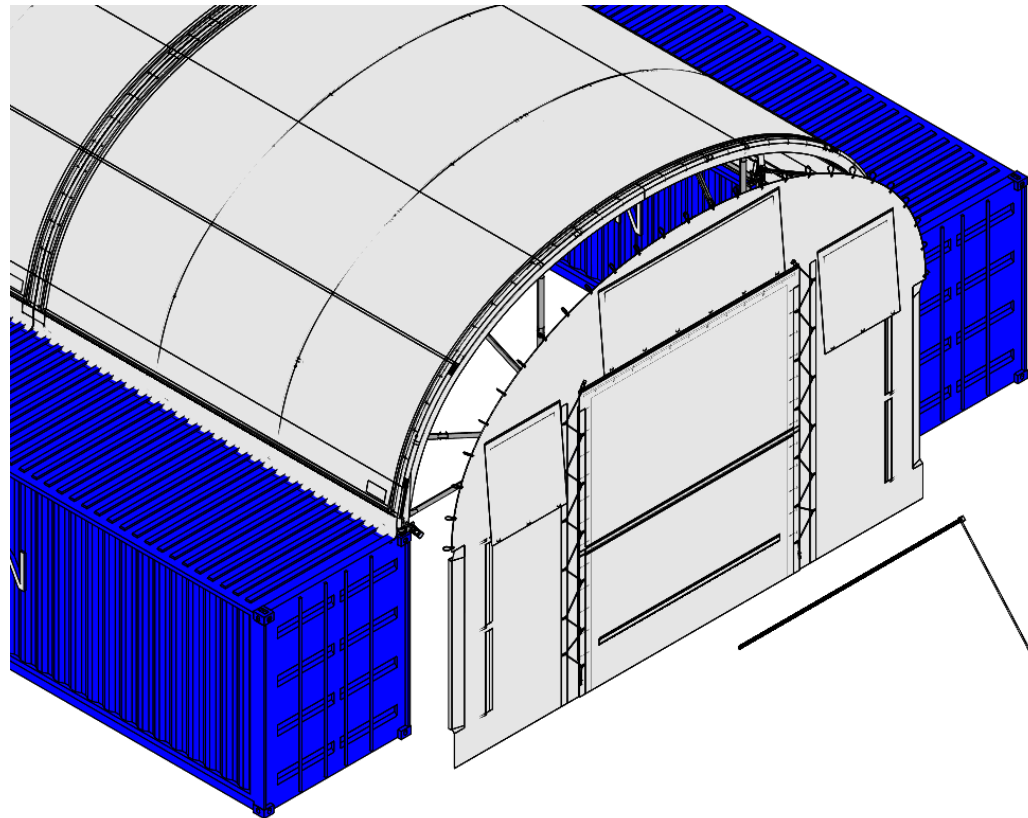

Manuel d'assemblage pour le couvercle de la paroi d'extrémité



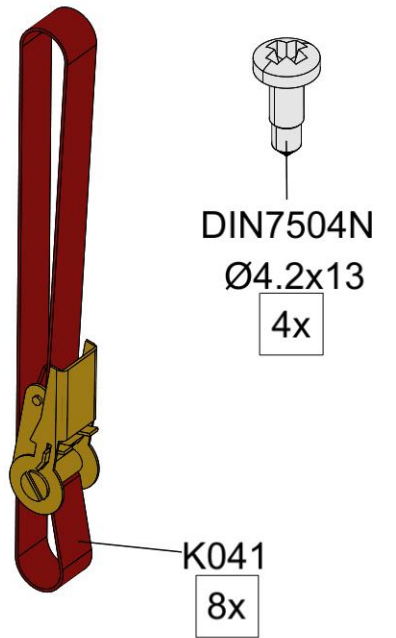
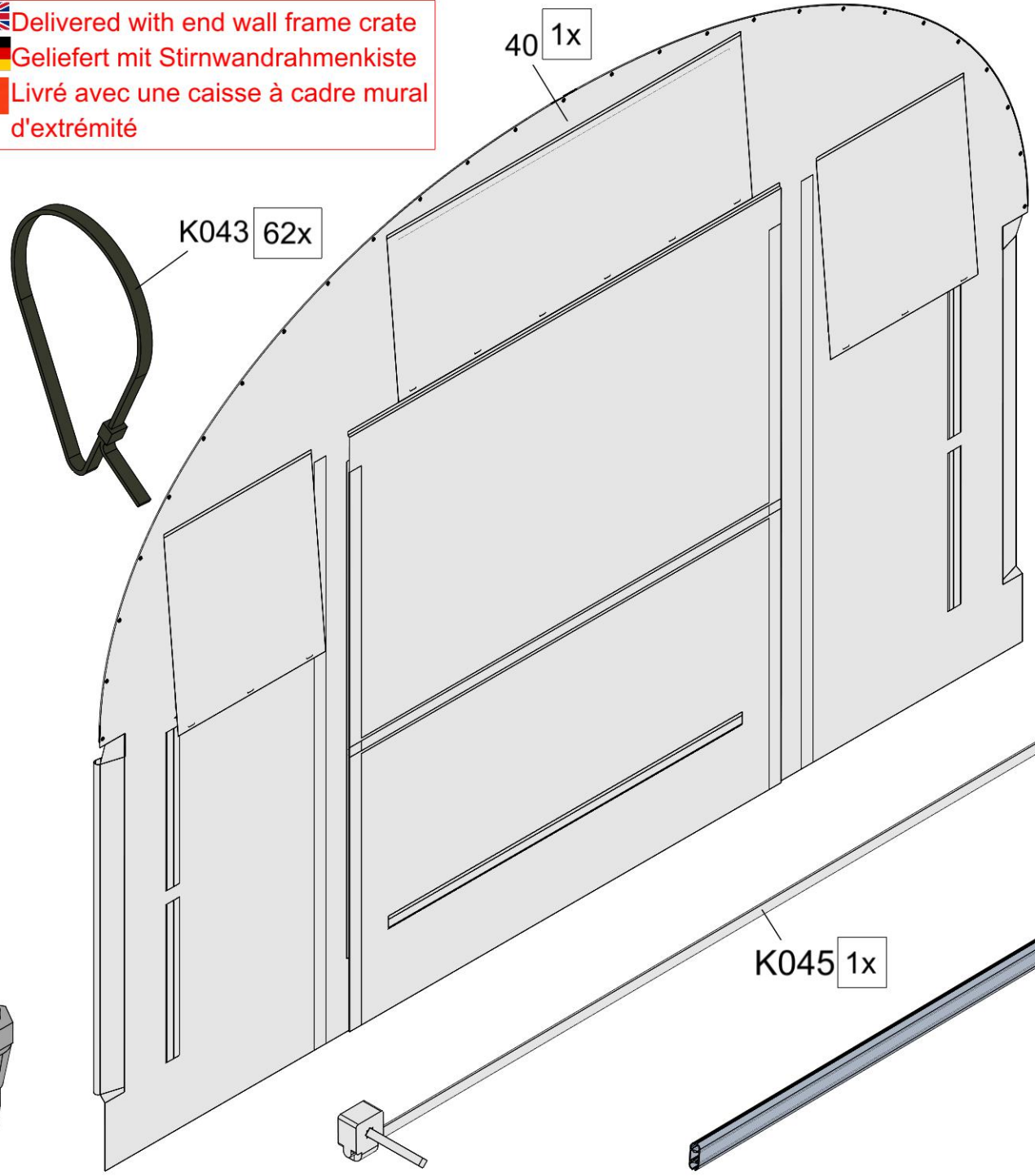
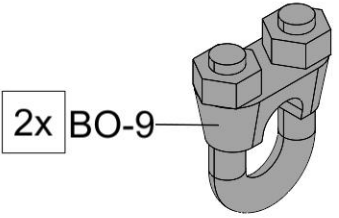
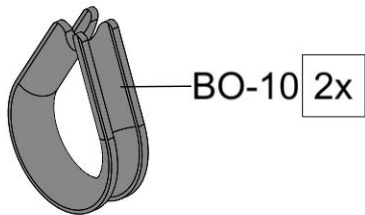
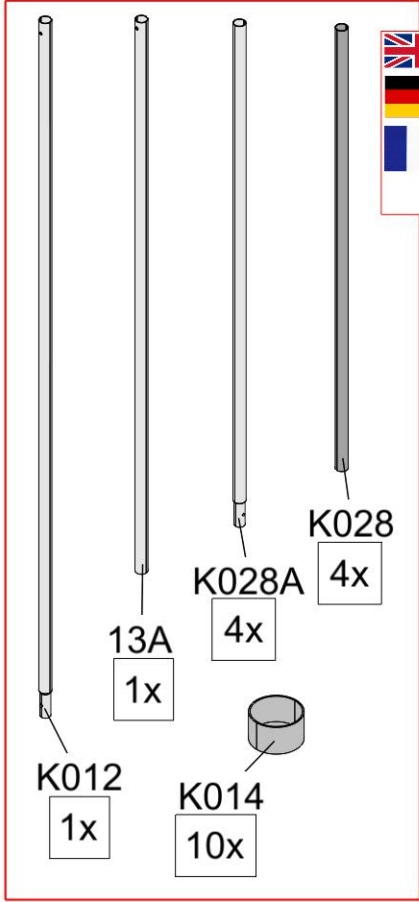

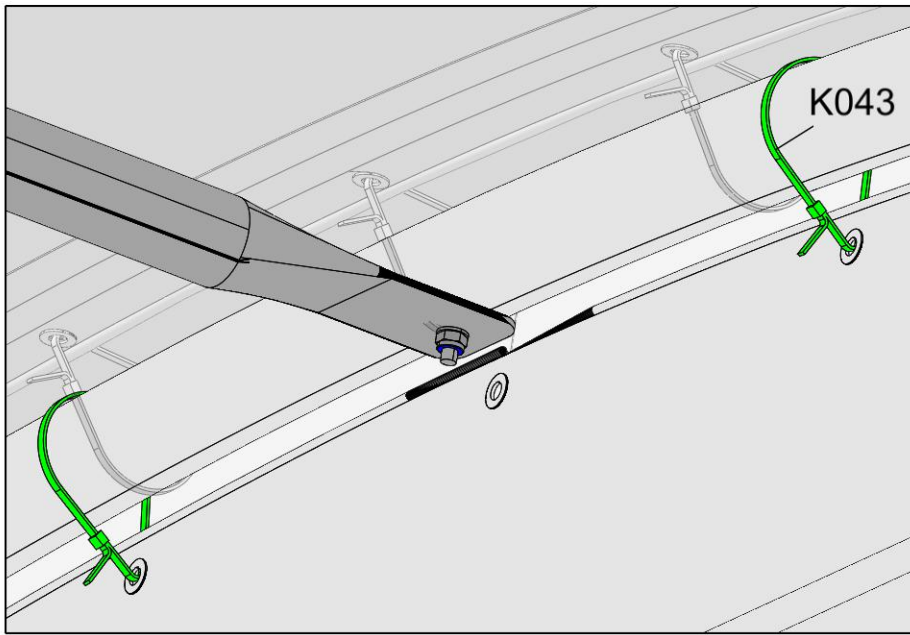
 Delivered with end wall frame crate
 Geliefert mit Stirwandrahmenkiste
 Livré avec une caisse à cadre mural d'extrémité







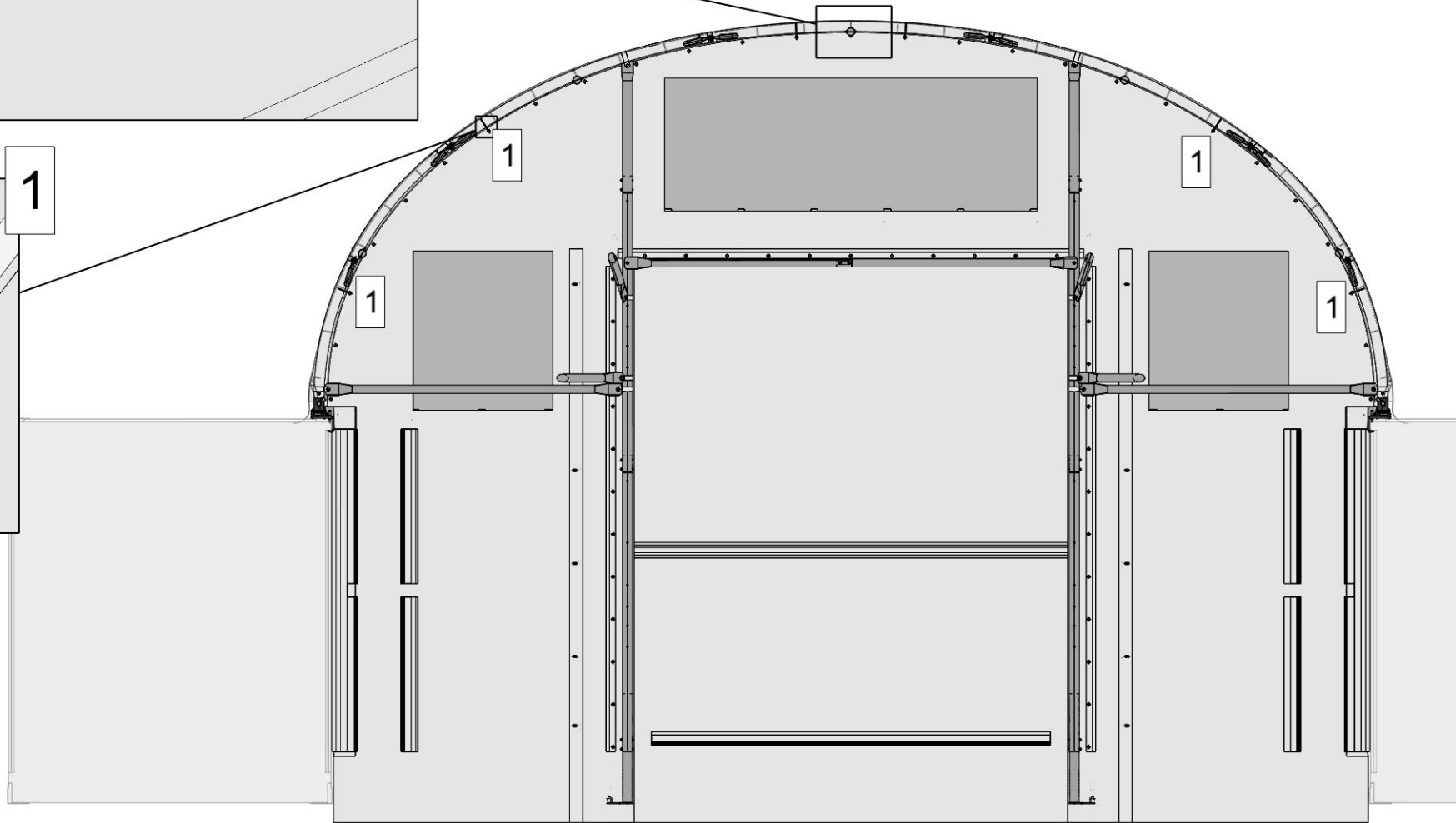
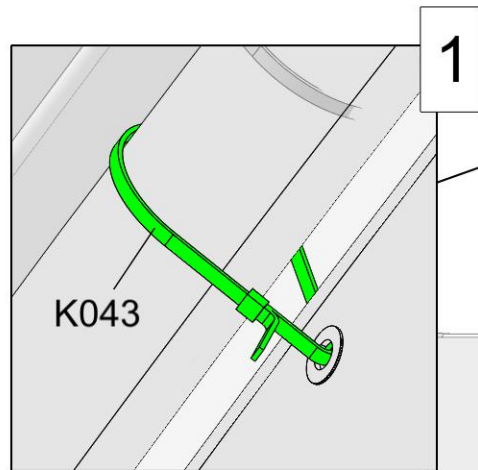

 Secure the cover here with 6 tie wraps
 Sichern Sie die Plane hier mit 6 Kabelbindern
 Fixer la couverture ici avec 6 attaches

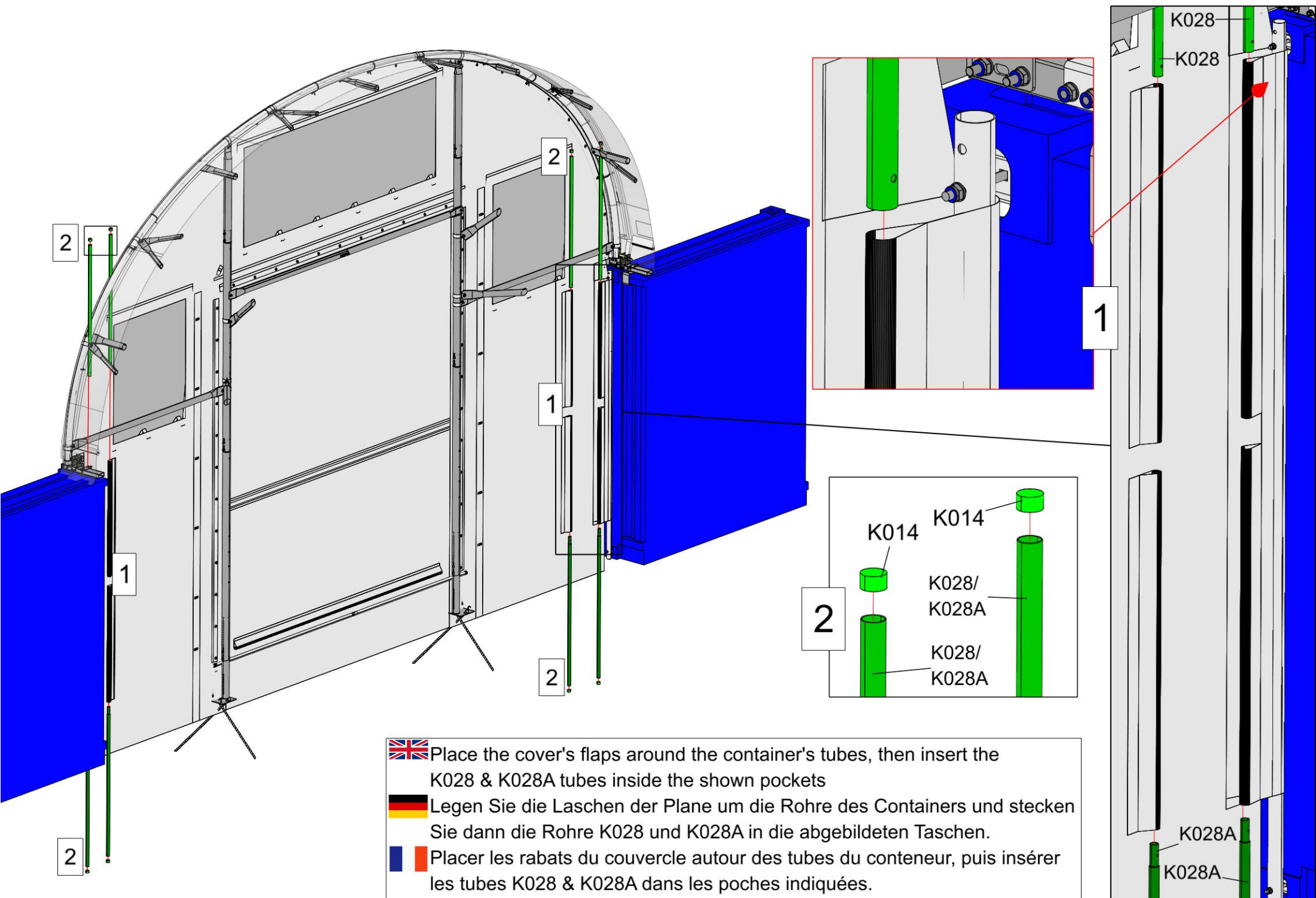

 Seen from the inside
 Von innen gesehen
 Vu de l'intérieur





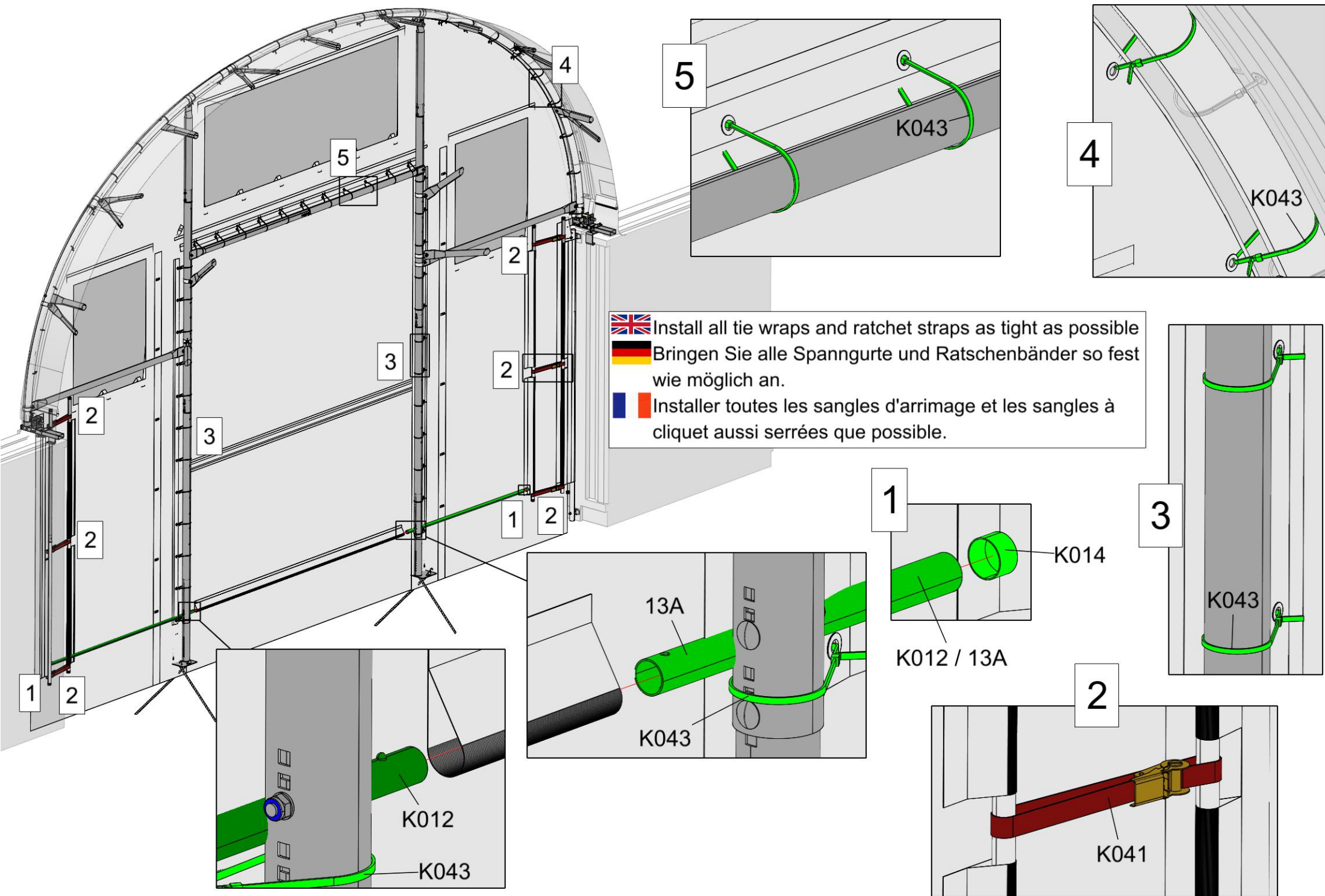



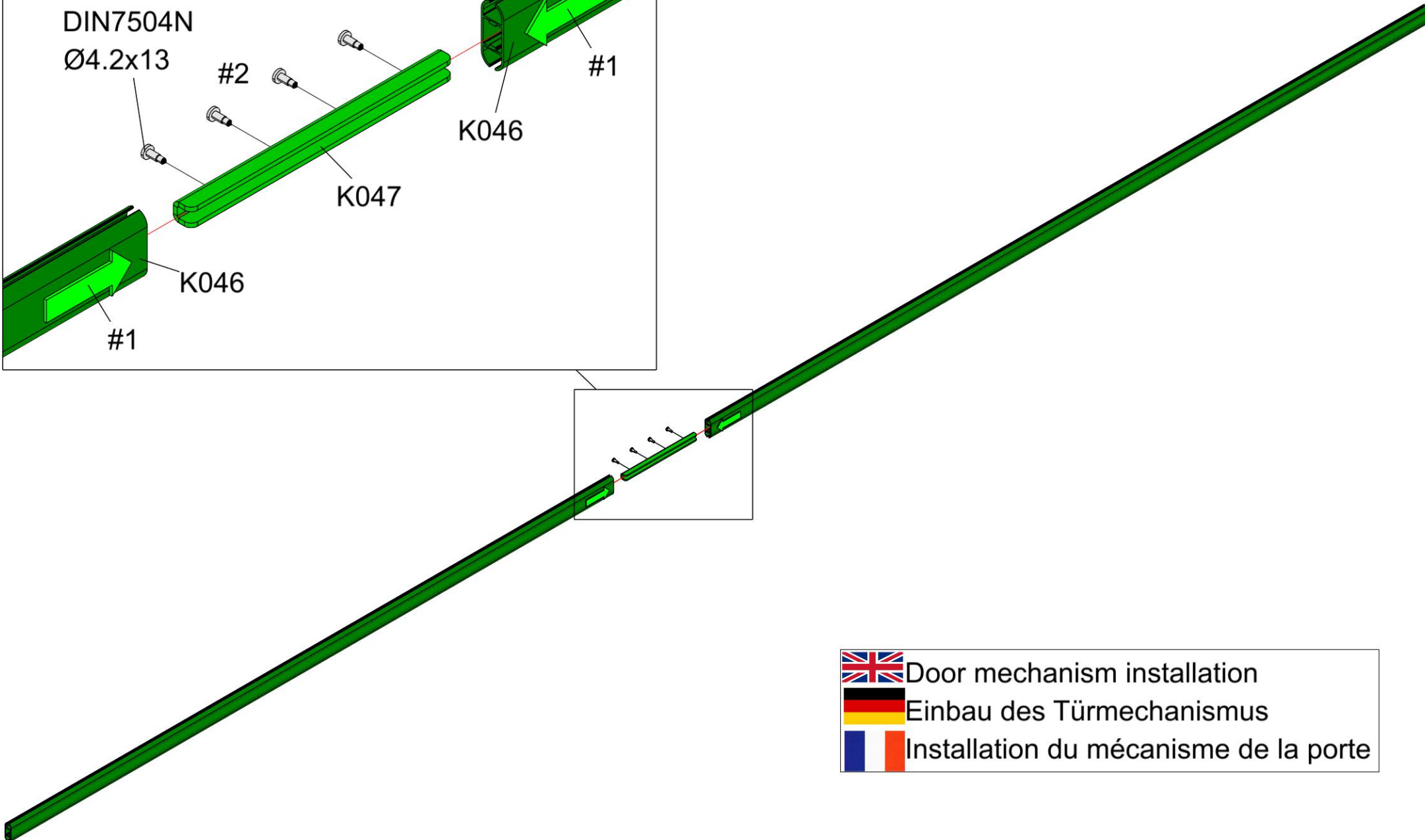
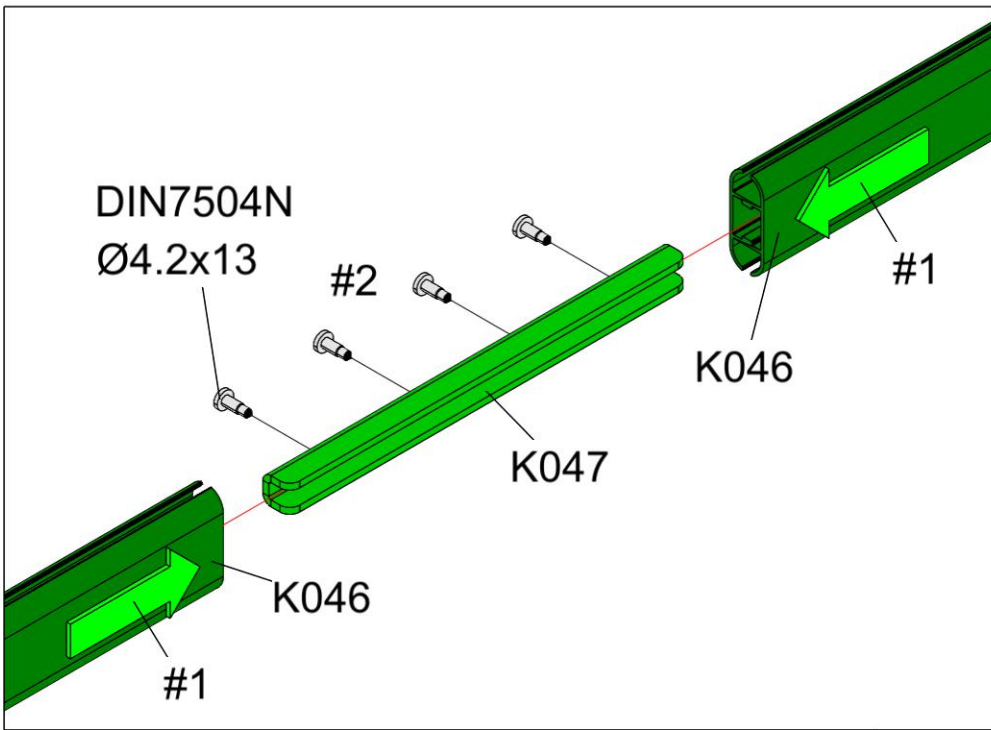

-  Place the cover's flaps around the container's tubes, then insert the K028 & K028A tubes inside the shown pockets
-  Legen Sie die Laschen der Plane um die Rohre des Containers und stecken Sie dann die Rohre K028 und K028A in die abgebildeten Taschen.
-  Placer les rabats du couvercle autour des tubes du conteneur, puis insérer les tubes K028 & K028A dans les poches indiquées.







 Install all tie wraps and ratchet straps as tight as possible
 Bringen Sie alle Spanngurte und Ratschenbänder so fest wie möglich an.
 Installer toutes les sangles d'arrimage et les sangles à cliquet aussi serrées que possible.

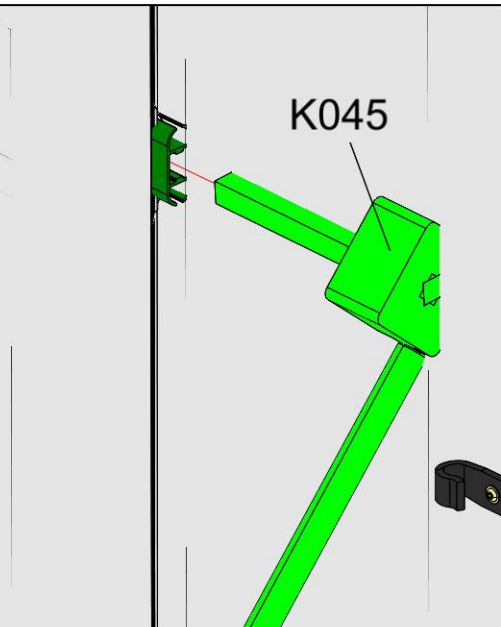
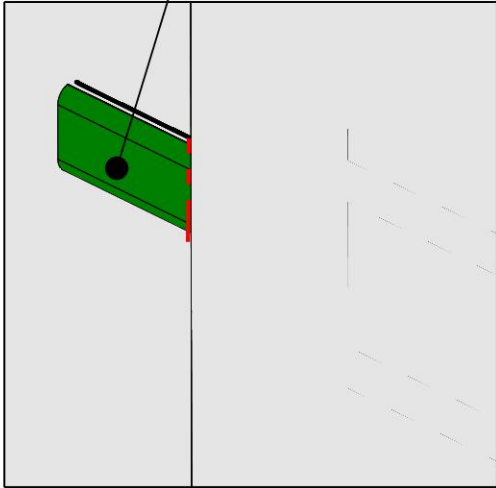

- | | |
|---|---------------------------------------|
|  | Door mechanism installation |
|  | Einbau des Türmechanismus |
|  | Installation du mécanisme de la porte |



 Cut to size of the door
 Zuschnitt auf die Größe
der Tor
 Couper à la taille de la
porte

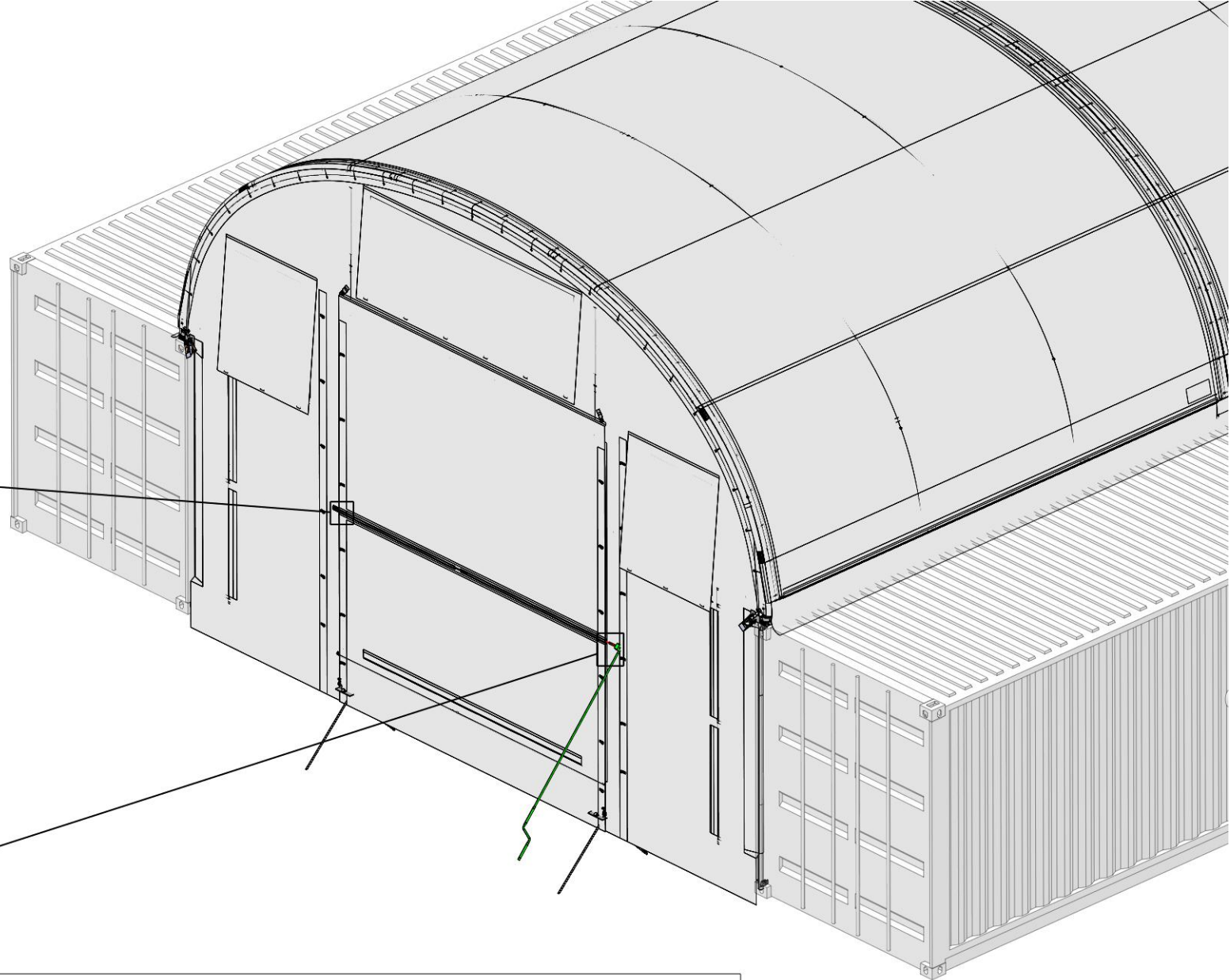

 Insert the door mechanism through its special pocket in the door
and attach the handle.
 Führen Sie den Türmechanismus in die dafür vorgesehene Tasche
in der Tür ein und befestigen Sie den Griff.
 Insérez le mécanisme de la porte dans la poche prévue à cet effet
dans la porte et fixez la poignée.

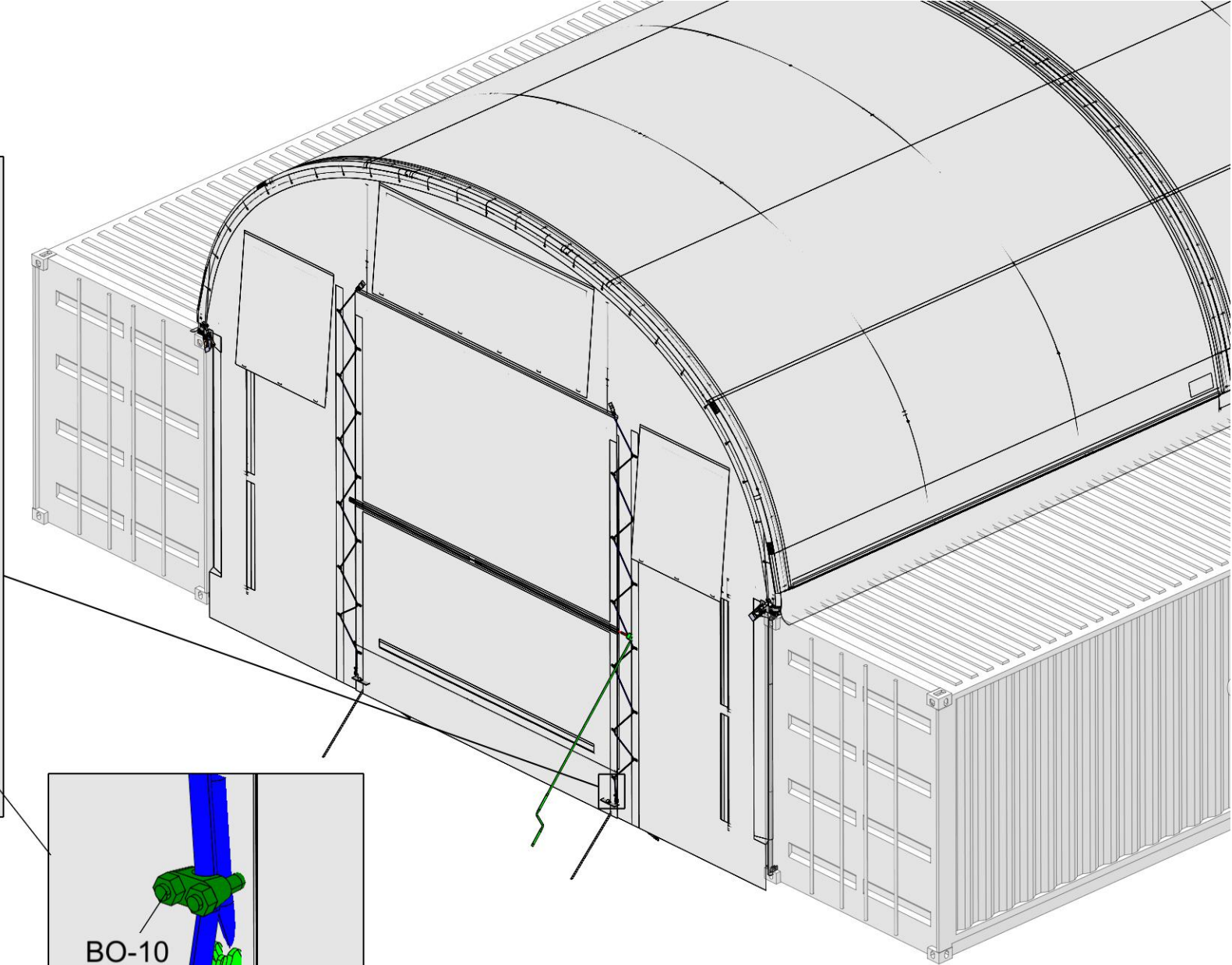
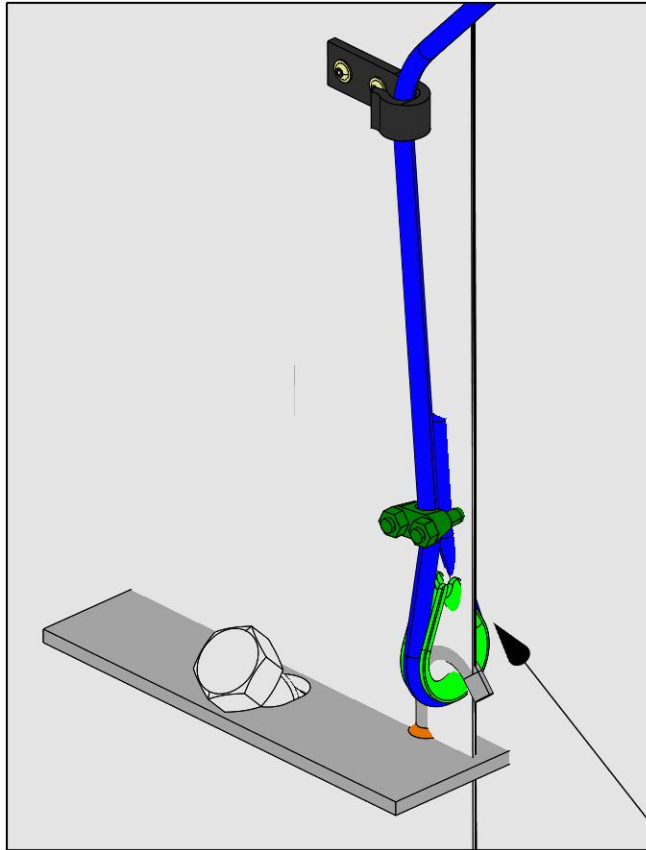



 Use the attached nylon ropes to tie the door cover to the base plate hooks
 Befestigen Sie die Tor mit den beiliegenden Nylonseilen an den Haken der Grundplatte.
 Utilisez les cordes en nylon jointes pour attacher le couvercle de la porte aux crochets de la plaque de base.

