

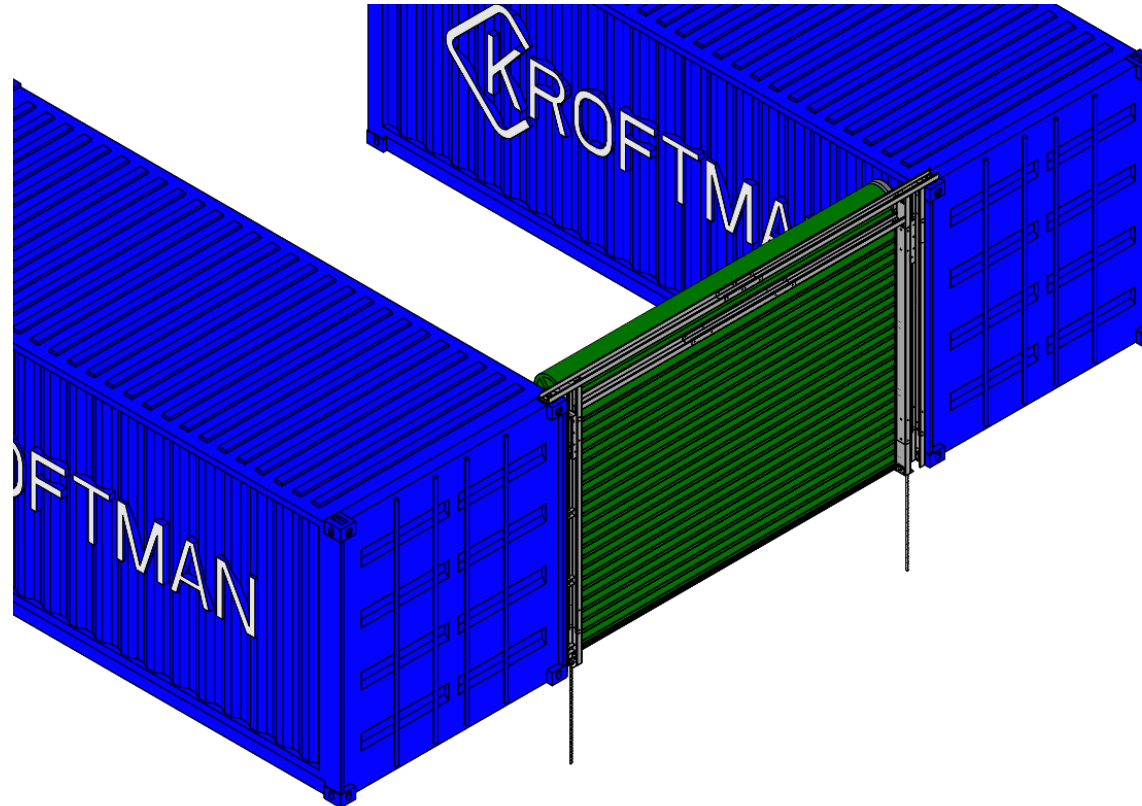



# KROFTMAN WB-400-RD



Assembly manual for end wall frame with roll-up door  
Montageanleitung für das Endwandrahmen mit Rolltor  
Manuel d'assemblage pour le cadre de mur latéral avec porte roulante

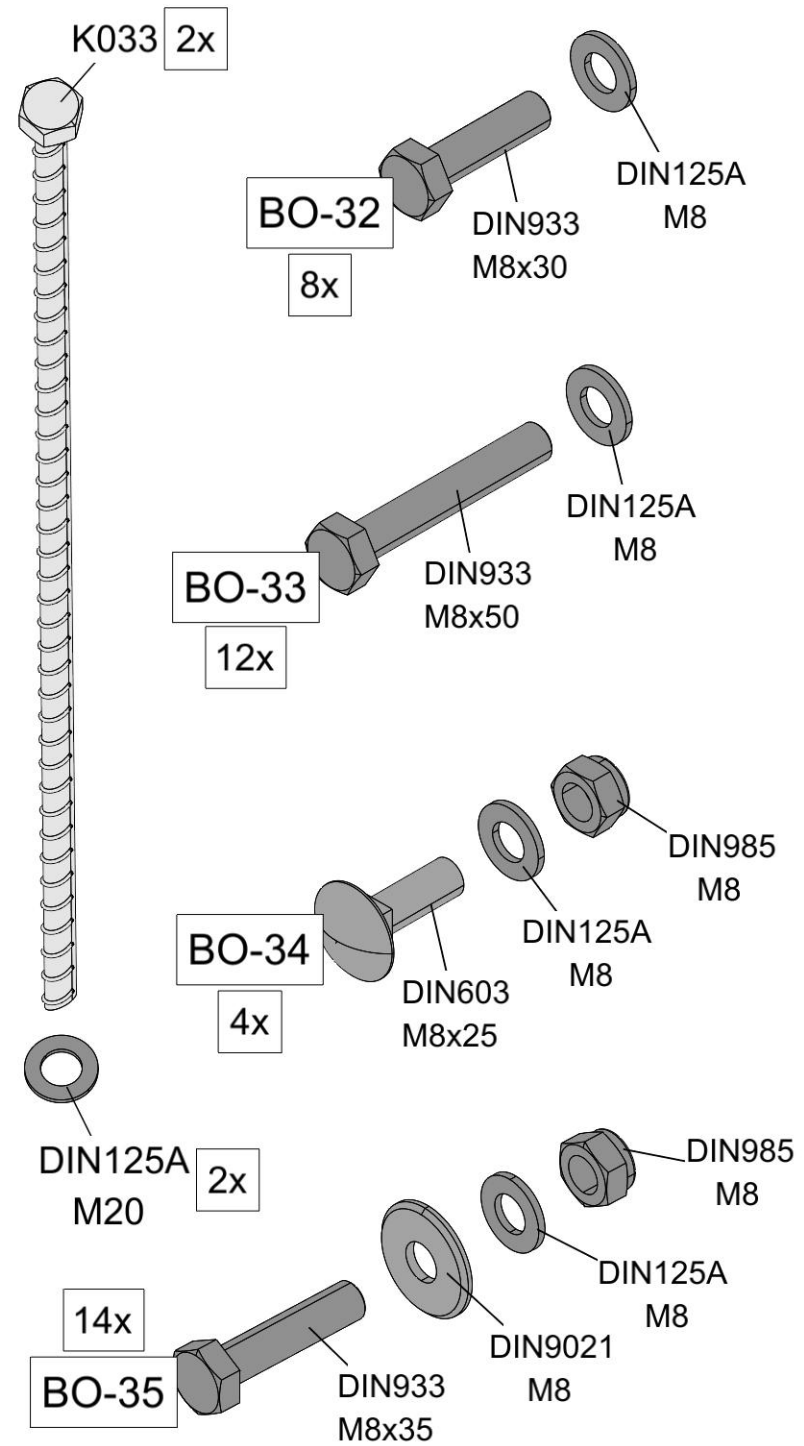
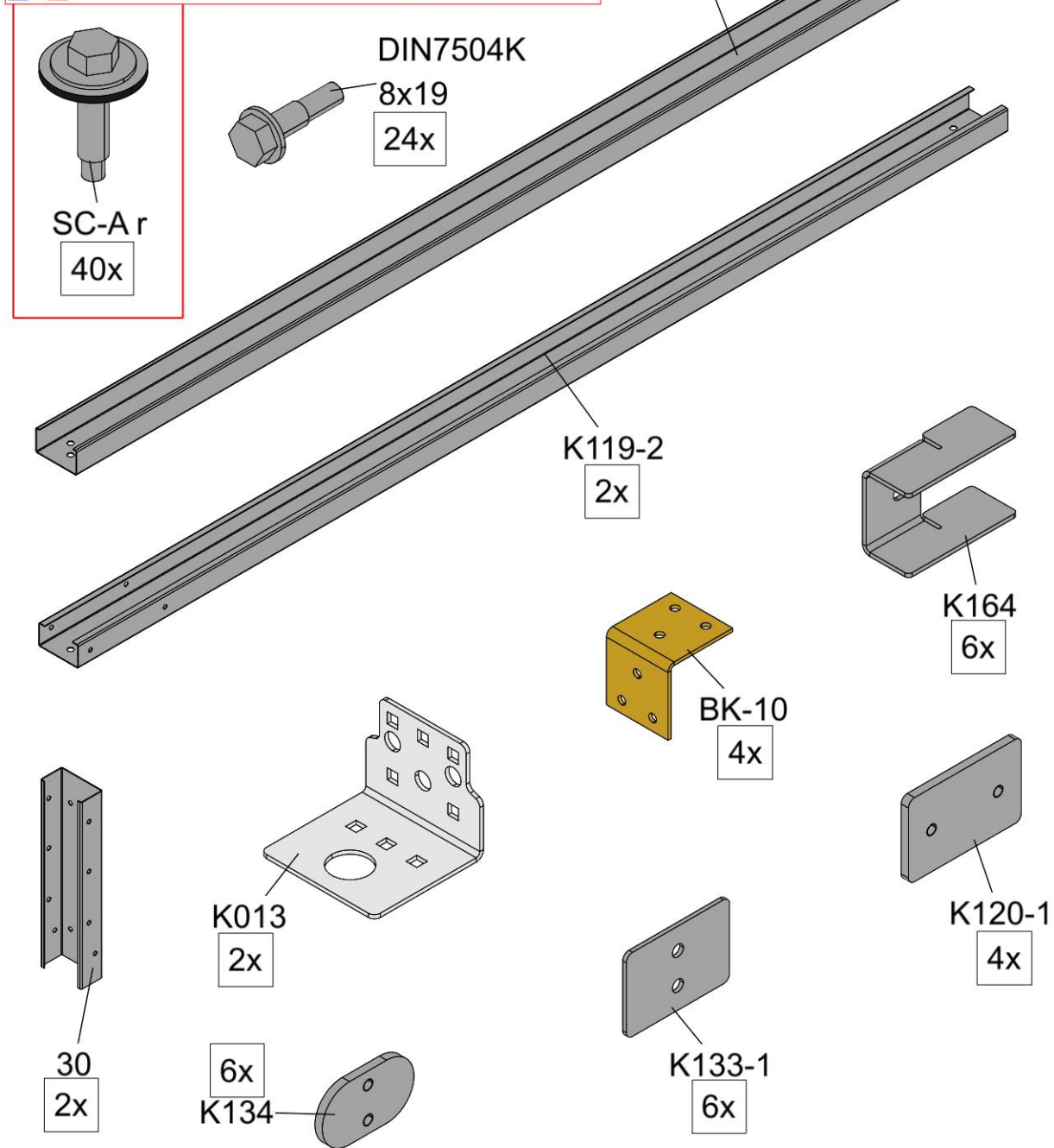

 Needed for trim assembly  
 Benötigt für die Verkleidungsmontage  
 Nécessaire pour l'assemblage de garniture

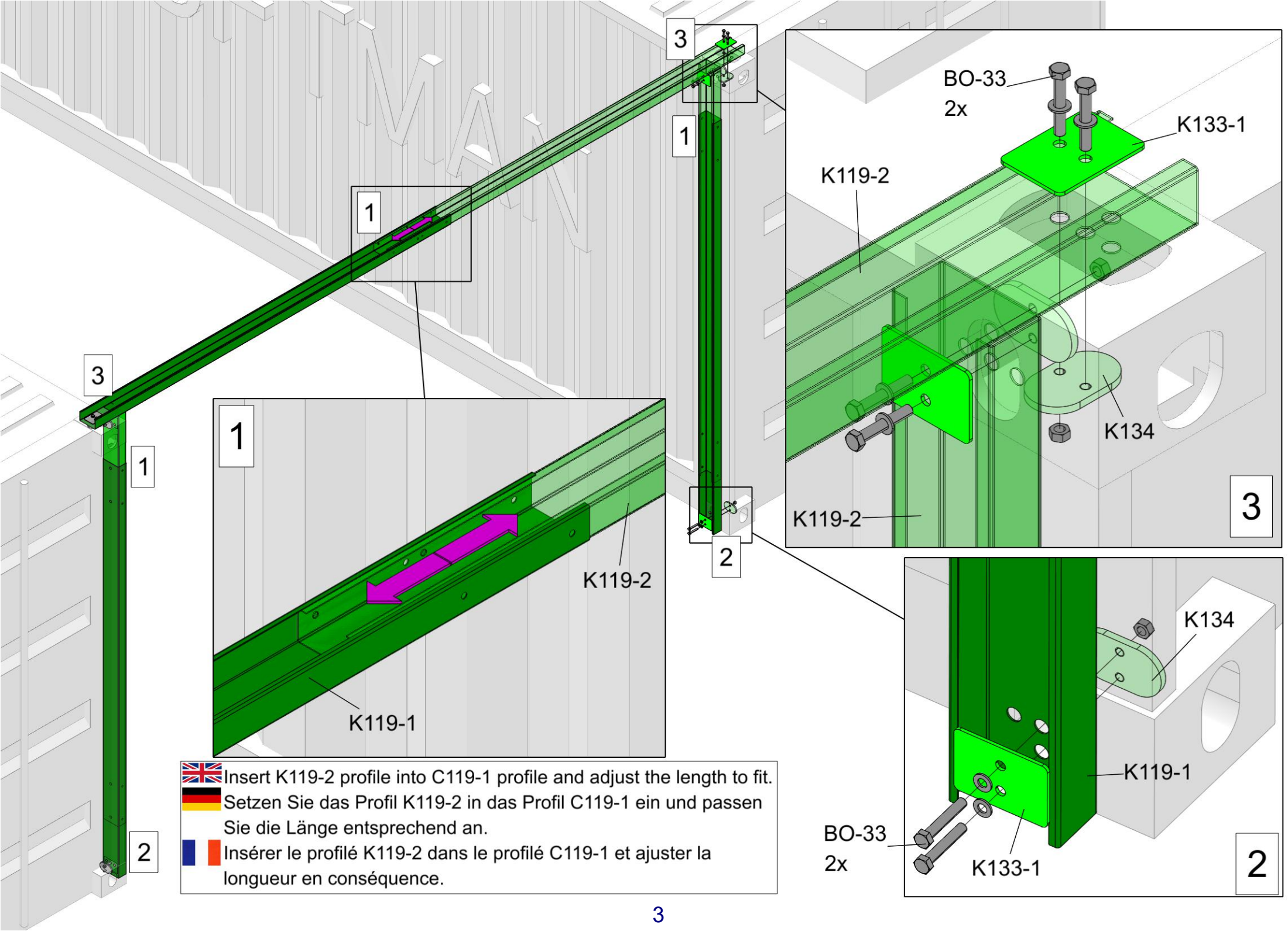







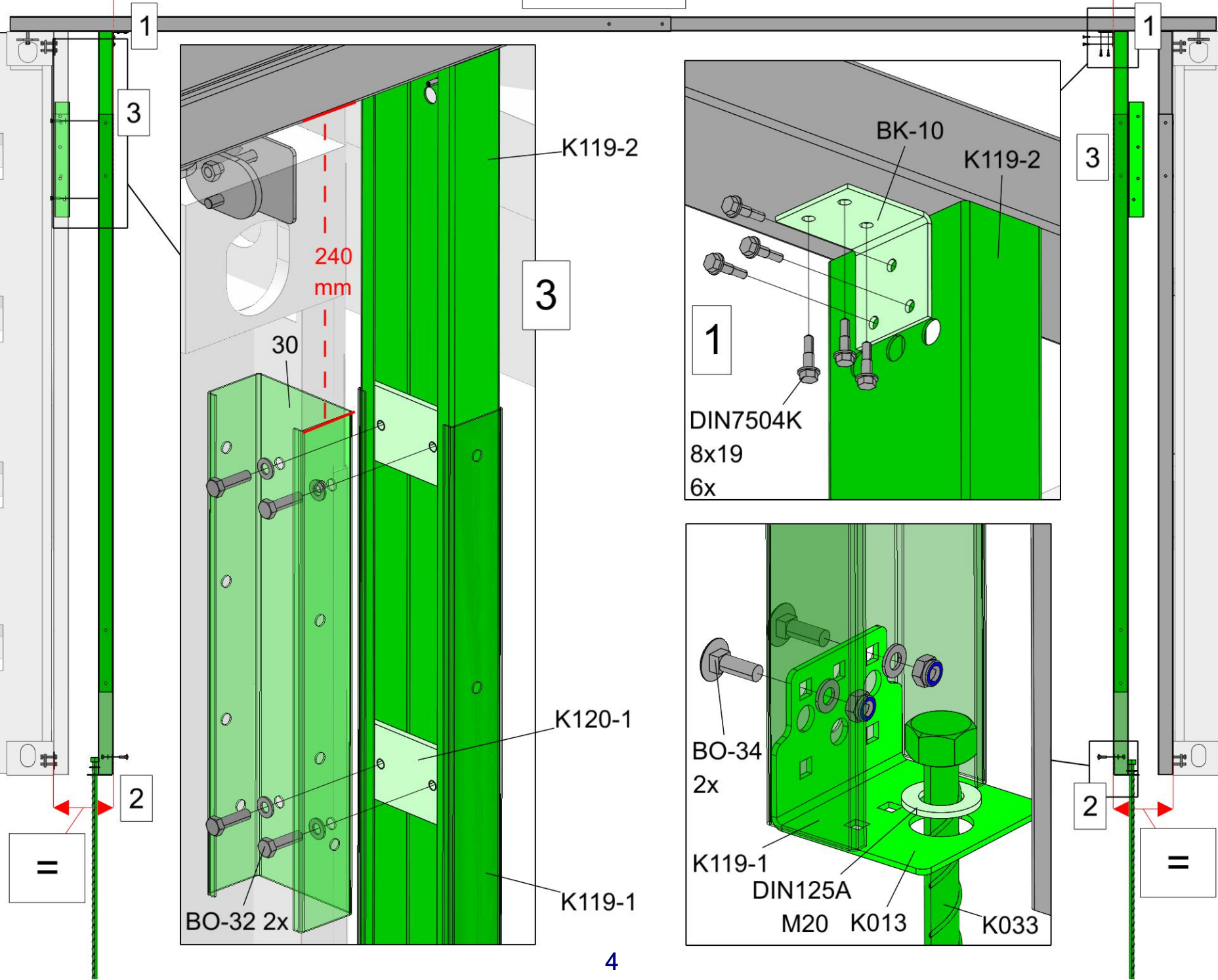

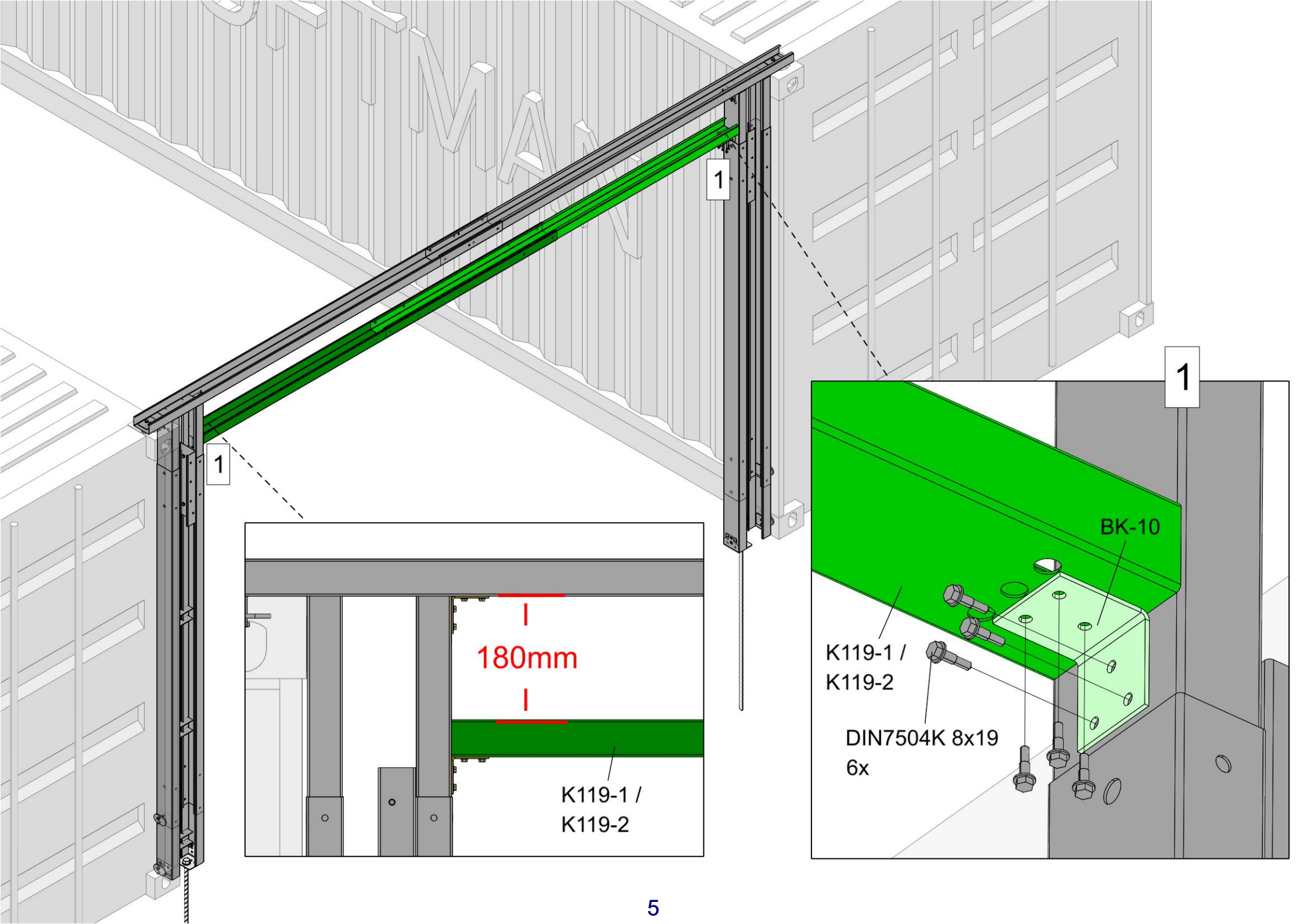
 Insert K119-2 profile into C119-1 profile and adjust the length to fit.  
 Setzen Sie das Profil K119-2 in das Profil C119-1 ein und passen Sie die Länge entsprechend an.  
 Insérer le profilé K119-2 dans le profilé C119-1 et ajuster la longueur en conséquence.

348±2cm





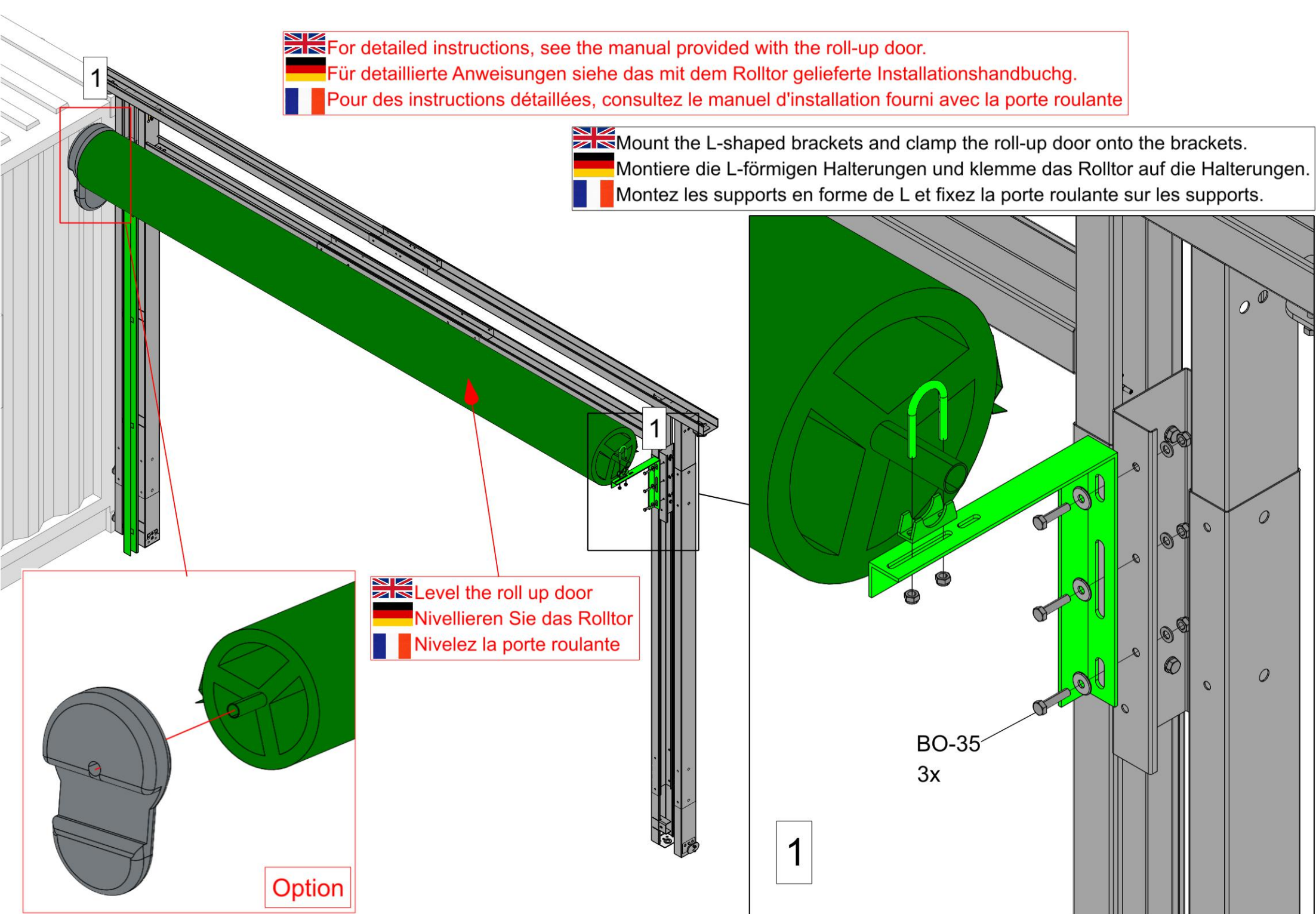

 For detailed instructions, see the manual provided with the roll-up door.  
 Für detaillierte Anweisungen siehe das mit dem Rolltor gelieferte Installationshandbuch.  
 Pour des instructions détaillées, consultez le manuel d'installation fourni avec la porte roulante

 Mount the L-shaped brackets and clamp the roll-up door onto the brackets.  
 Montiere die L-förmigen Halterungen und klemme das Rolltor auf die Halterungen.  
 Montez les supports en forme de L et fixez la porte roulante sur les supports.



 Level the roll up door  
 Nivellieren Sie das Rolltor  
 Nivelez la porte roulante

Option

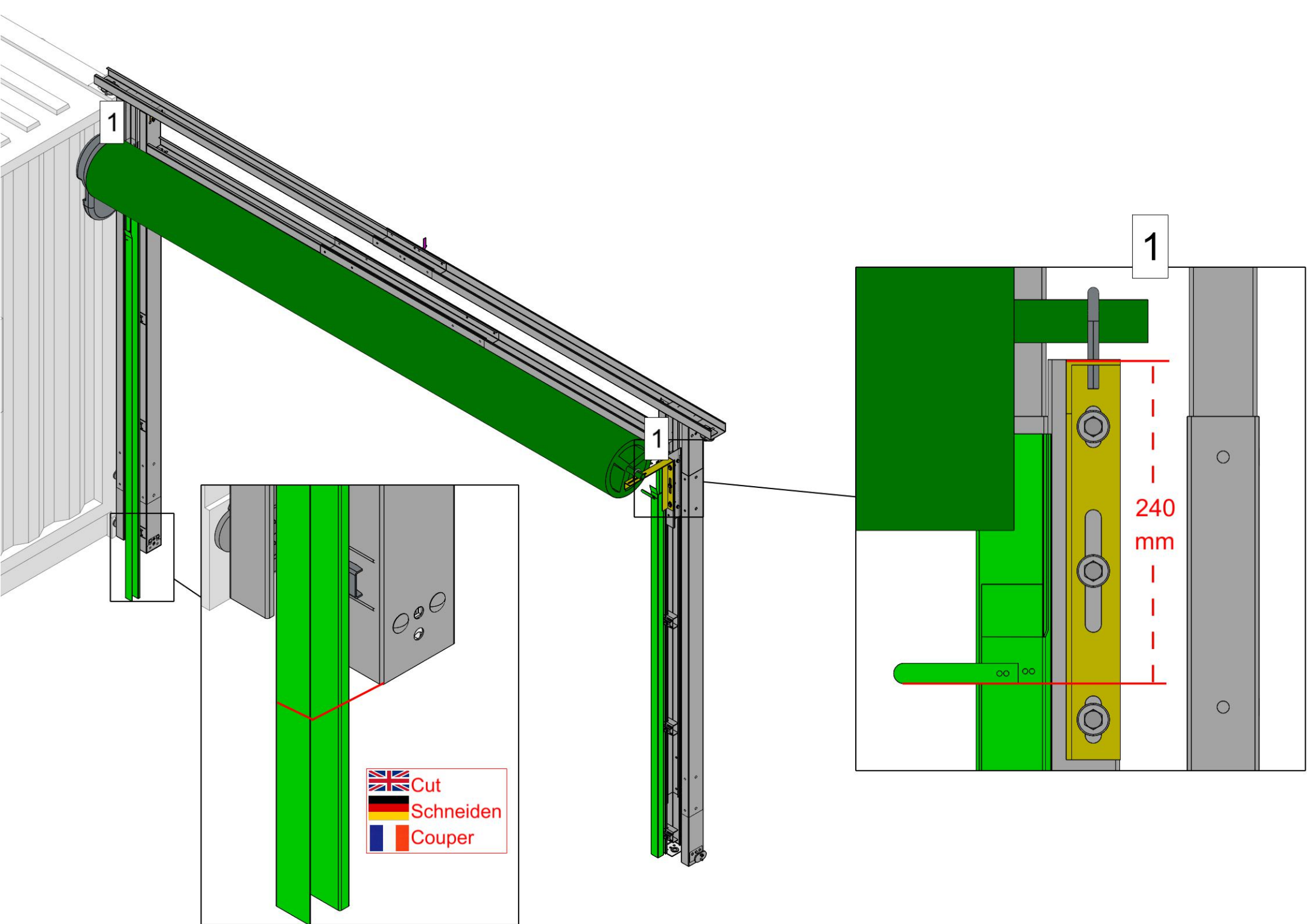



Drop the roll-up door halfway, slide the guides in place and fasten with the clamps



Lassen Sie das Rolltor bis zur Hälfte herunter, schieben Sie die Führungen an ihren Platz und befestigen Sie sie mit den Klemmen



Abaissez la porte roulante à moitié, glissez les guides en place et fixez-les avec les pinces

