

Container shelter/ Containerüberdachung / Abris sur containers



# KROFTMAN WB-400-CL

Assembly manual for closed end wall

Montageanleitung für geschlossene Stirnwand

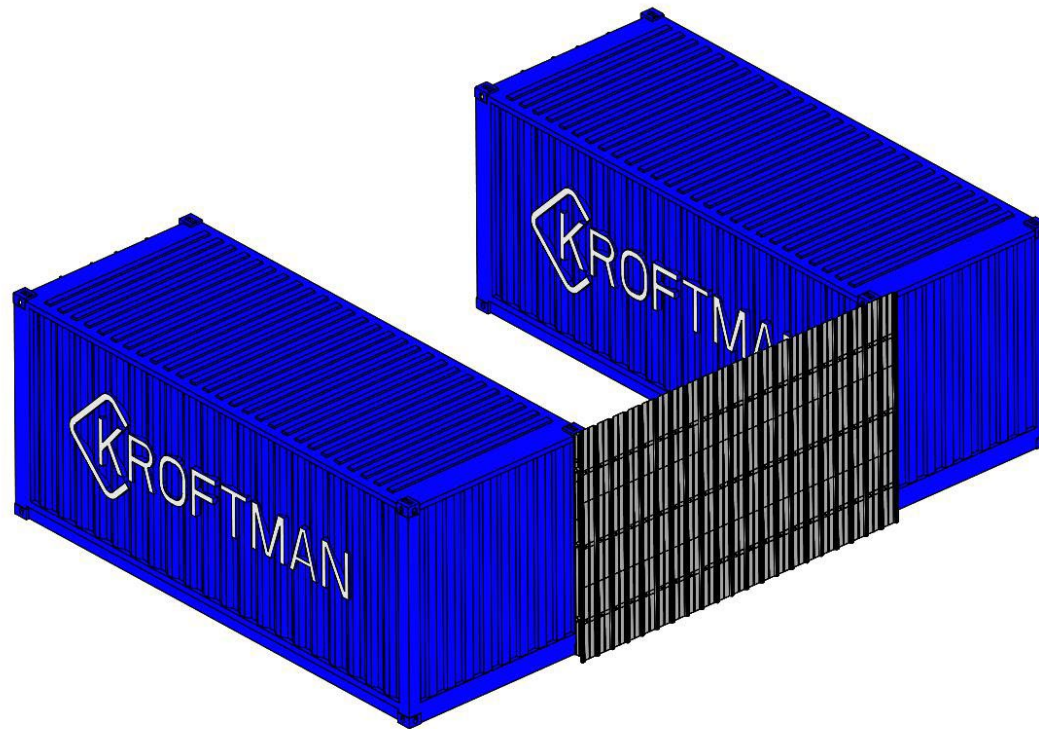
Manuel d'assemblage pour paroi fermée



 Make sure that the containers are parallel and placed to the specified dimensions.  
 Vergewissern Sie sich, dass die Behälter parallel zueinander und entsprechend den vorgegebenen Abmessungen aufgestellt sind.  
 Veillez à ce que les conteneurs soient parallèles et placés aux dimensions spécifiées.

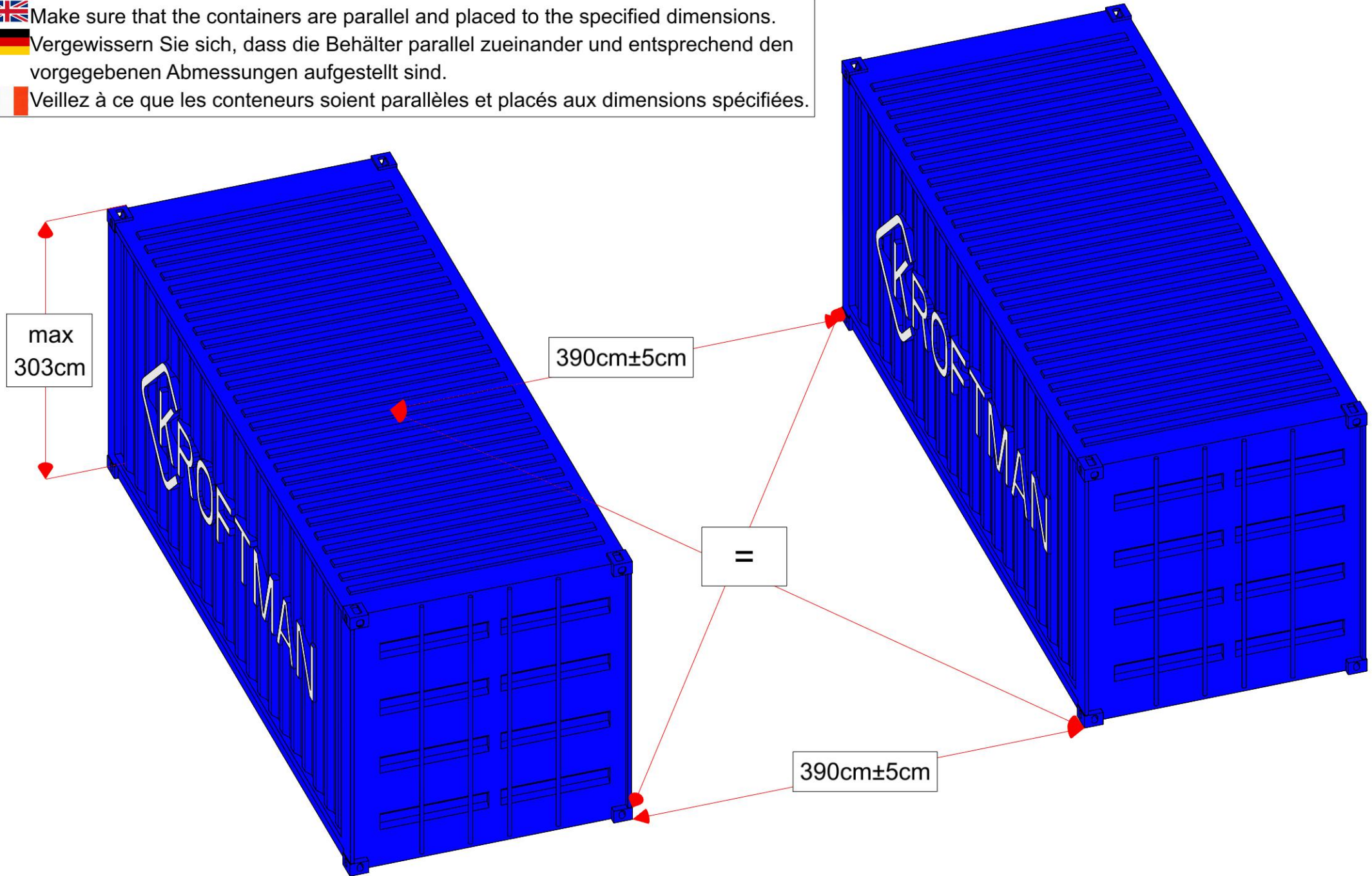

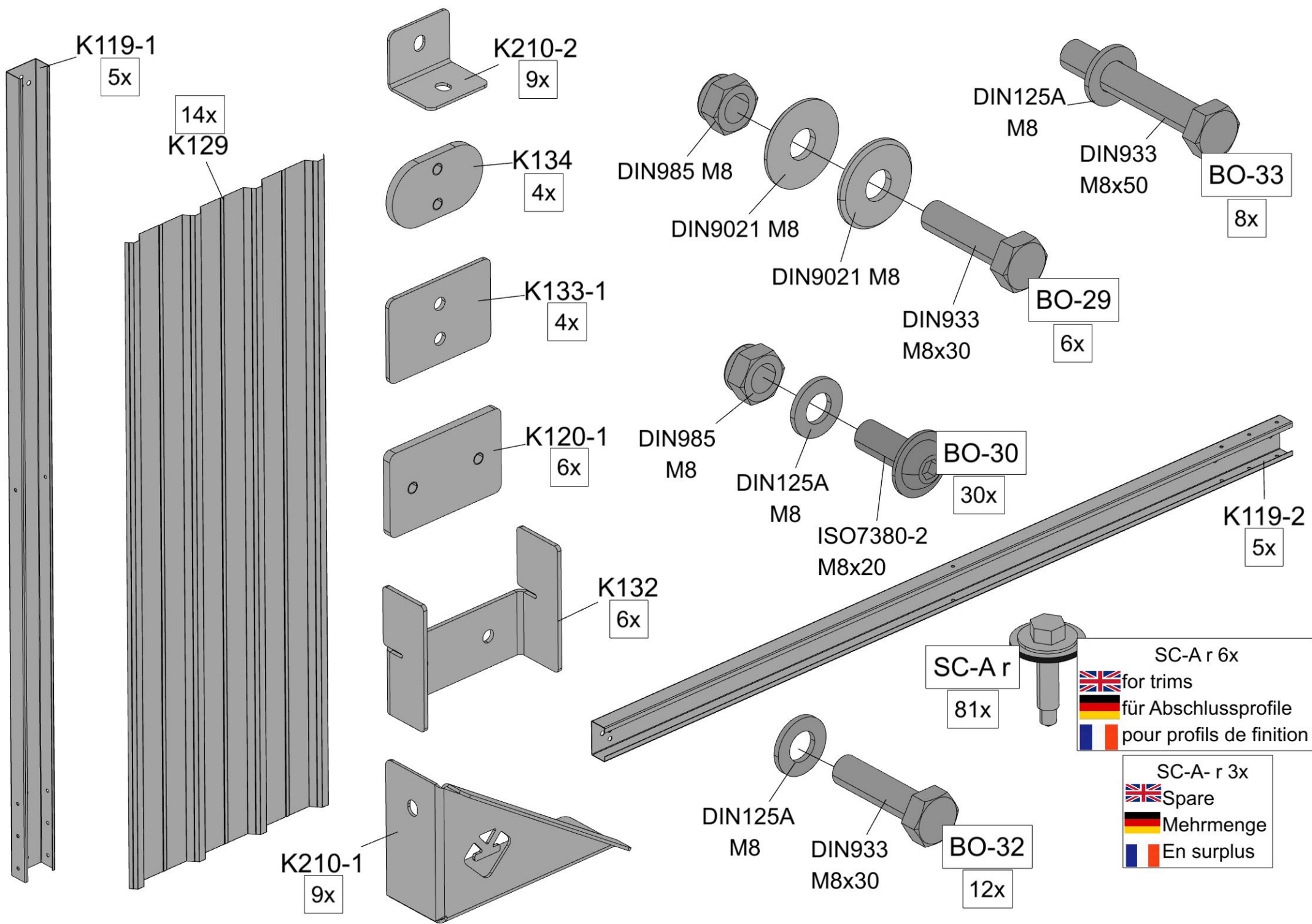

SC-A r 6x  
 for trims  
 für Abschlussprofile  
 pour profils de finition

SC-A-r 3x  
 Spare  
 Mehrmenge  
 En surplus

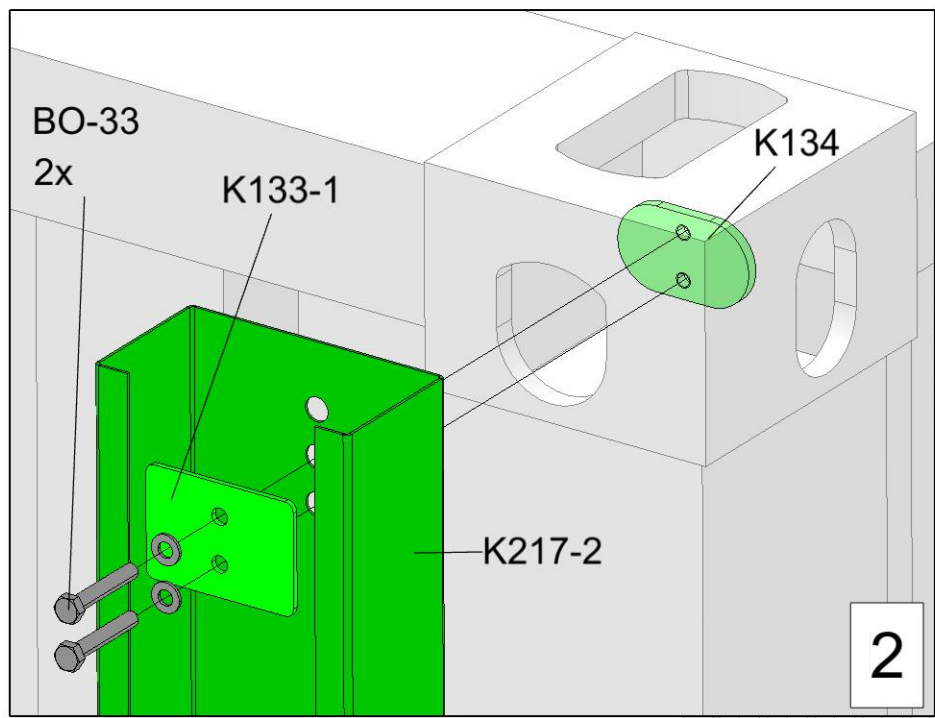

BO-33  
2x

K133-1

K134

K217-2

2

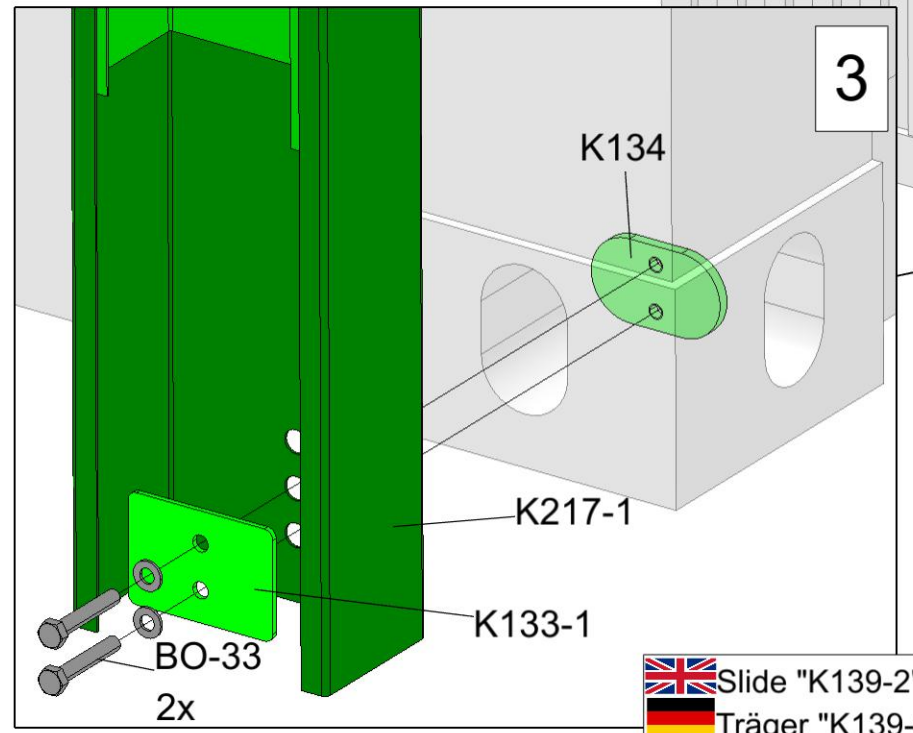

K134

K217-1

K133-1

BO-33  
2x

3

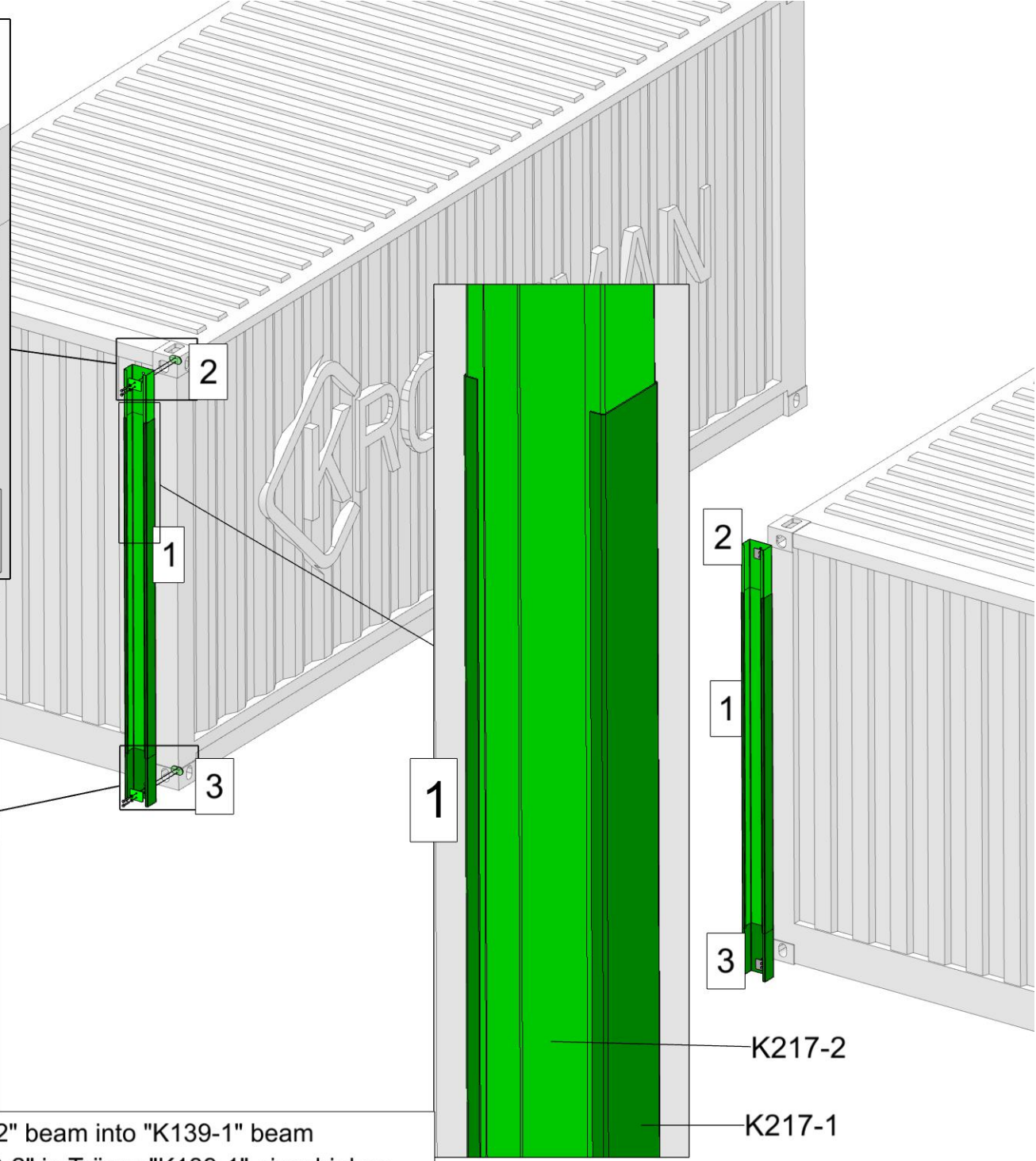

1



2

1



3

K217-2

K217-1

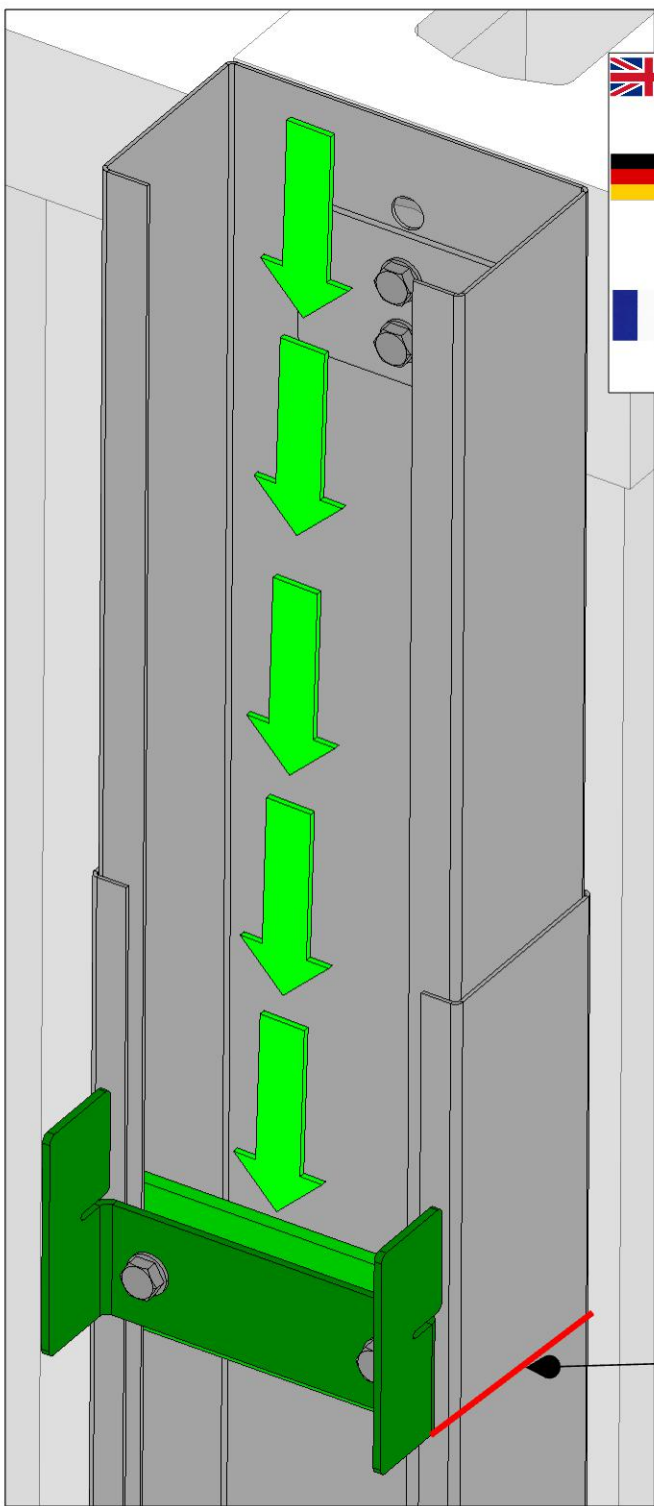
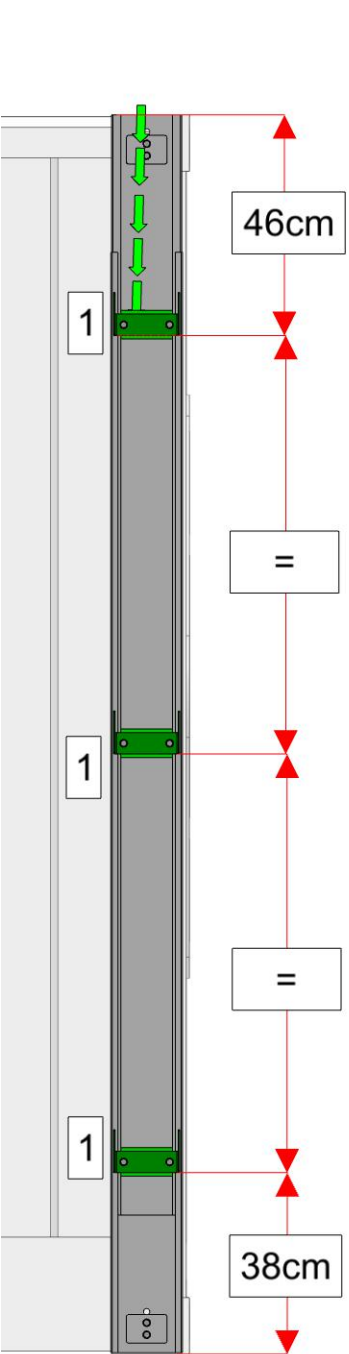



 Slide "K139-2" beam into "K139-1" beam  
 Träger "K139-2" in Träger "K139-1" einschieben  
 Glisser la poutre "K139-2" dans la poutre "K139-1".

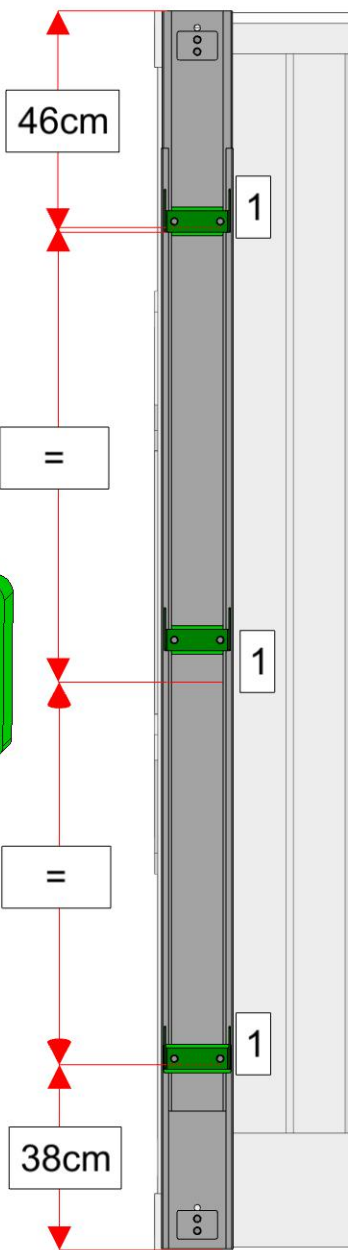
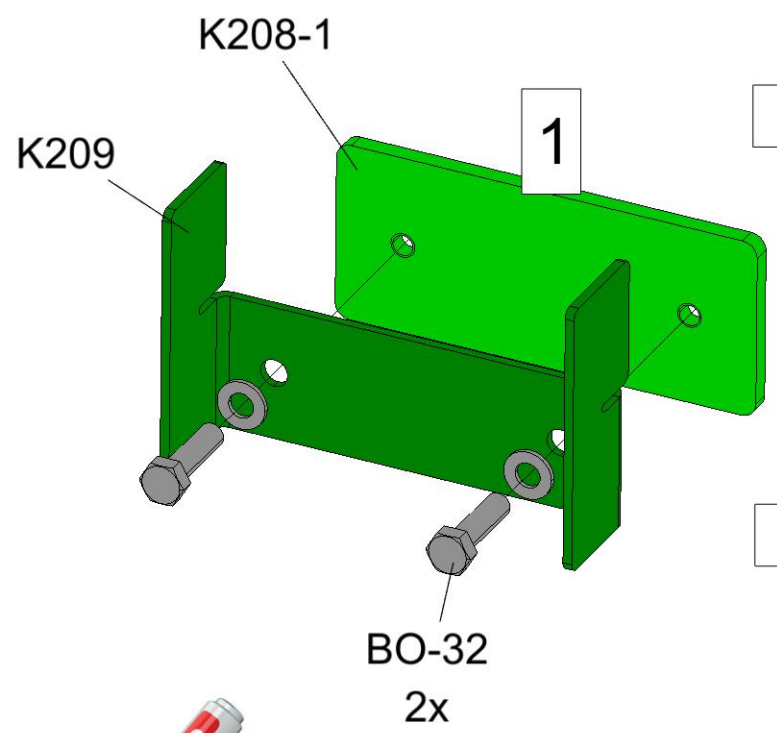

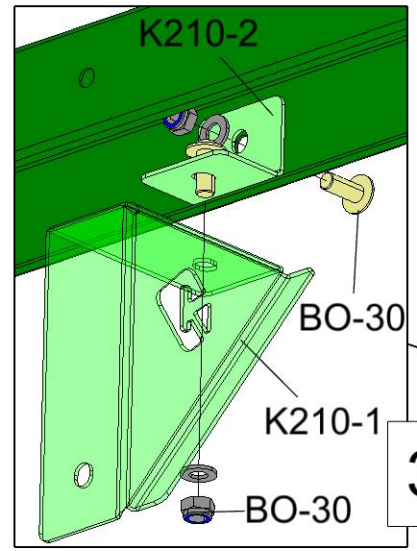
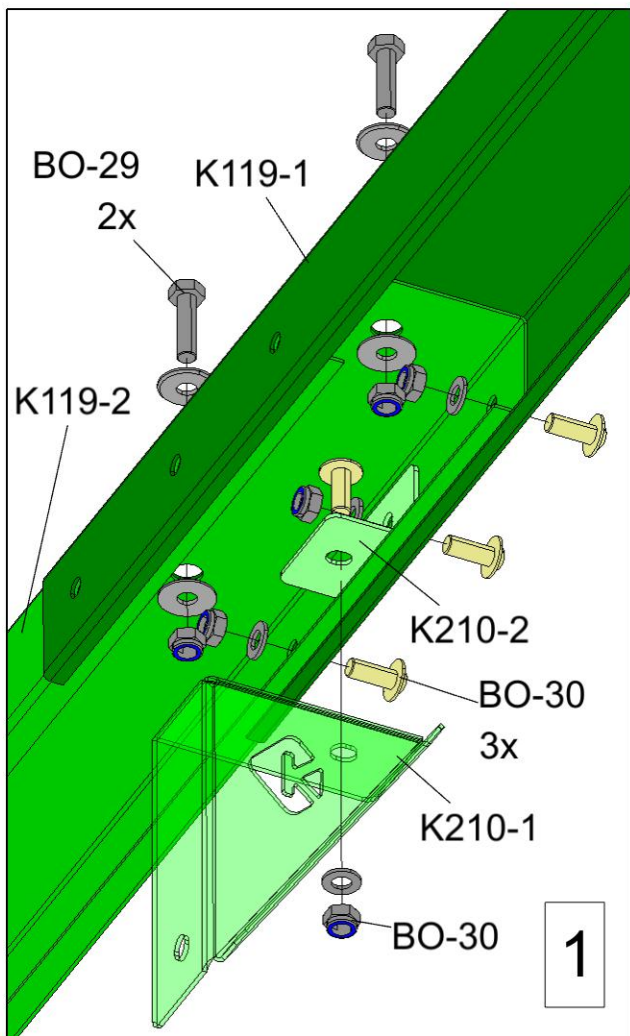
 Insert the clamps from the top of the rails, slide them to the specified position and mark the spot.  
 Setzen Sie die Klemmen von oben in die Schienen ein, schieben Sie sie in die gewünschte Position und markieren Sie die Stelle.  
 Insérer les pinces par le haut des rails, les faire glisser jusqu'à la position spécifiée et marquer l'emplacement.







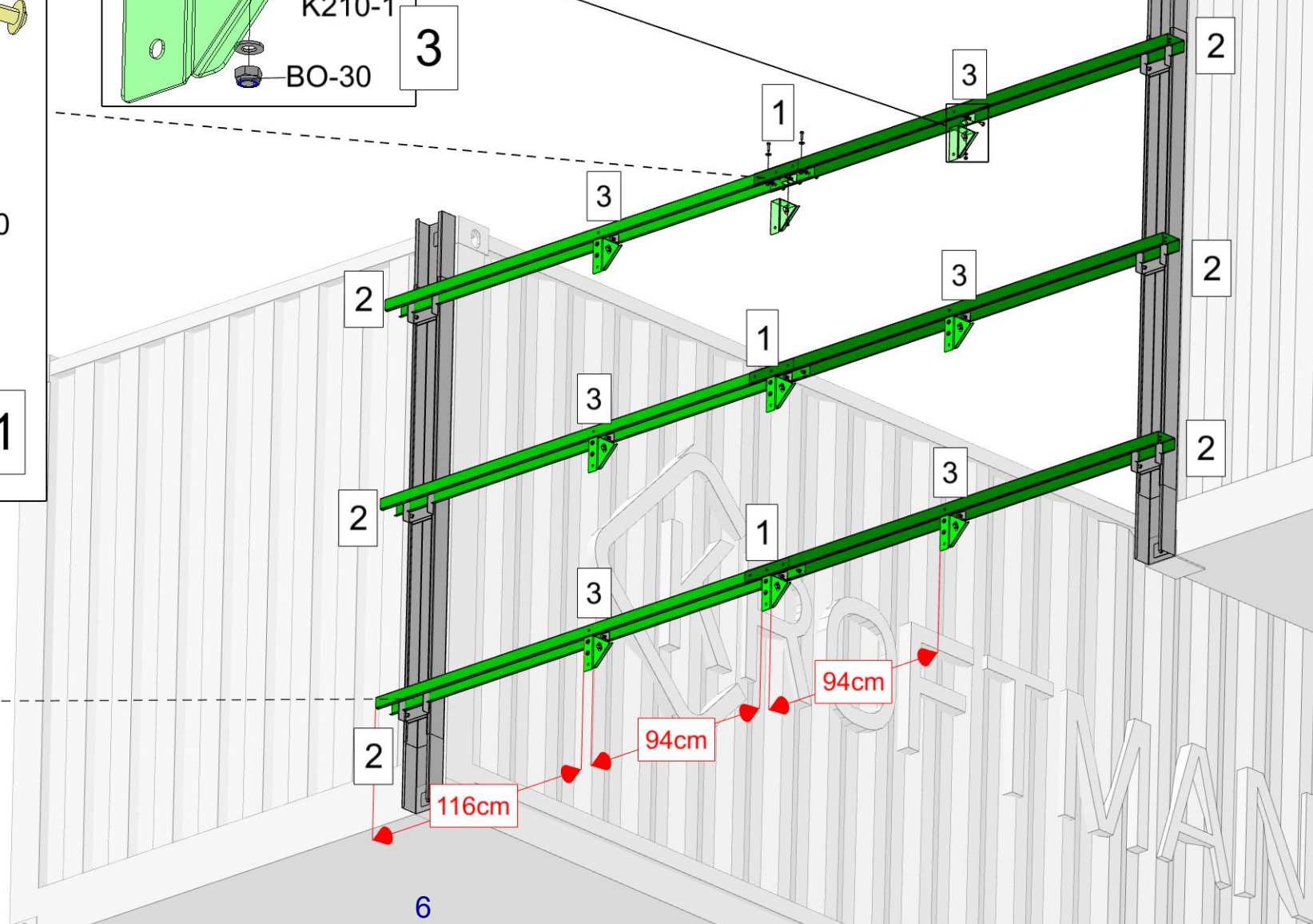
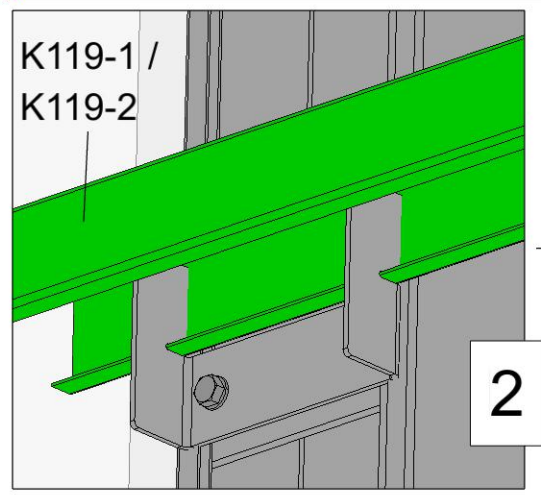

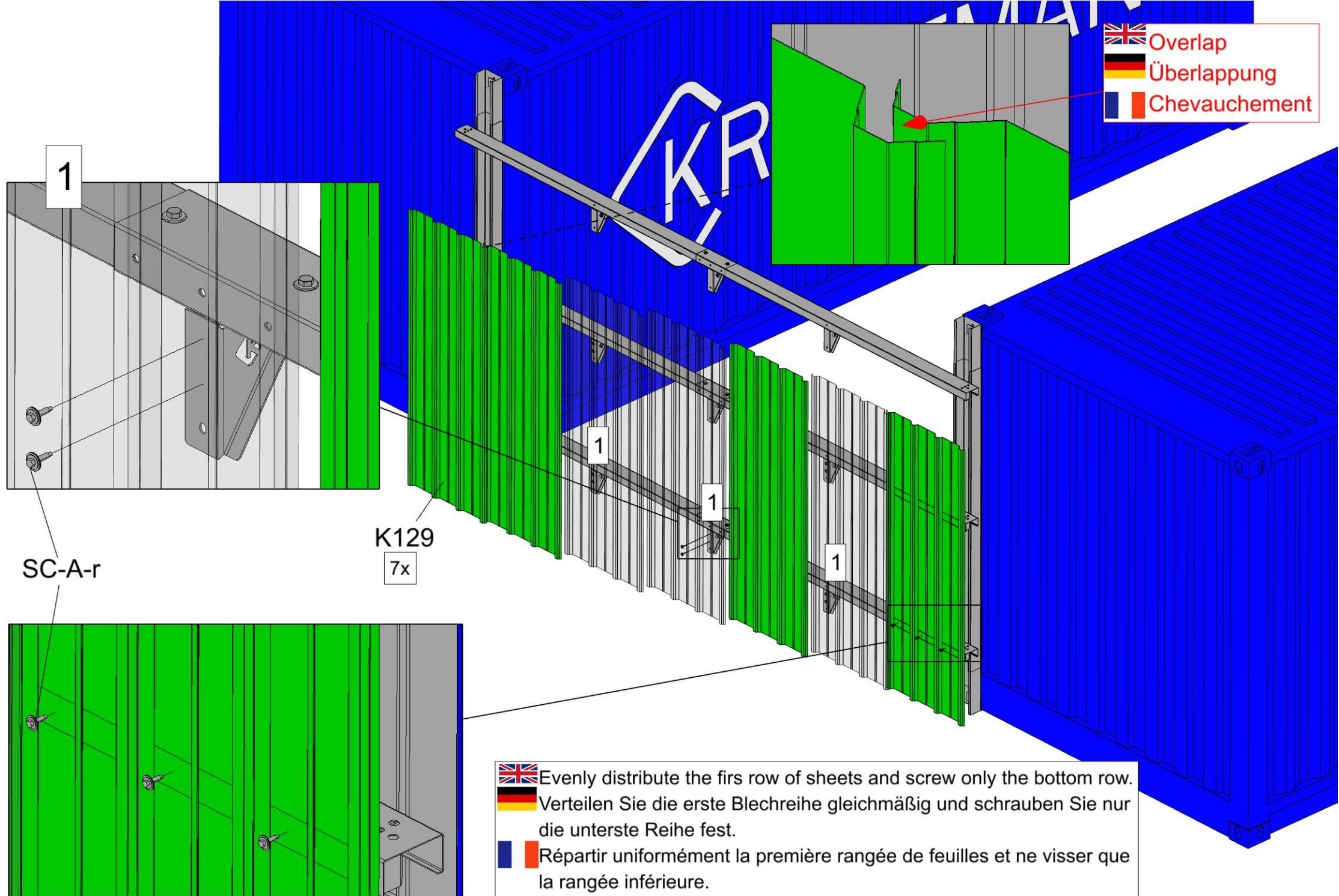

 Slide the beams through the clamps and tighten the bolts to fix them  
 Schieben Sie die Balken durch die Klammern und ziehen Sie die Schrauben an, um sie zu befestigen.  
  Faites glisser les poutres dans les pinces et serrez les boulons pour les fixer.





 Overlap  
 Überlappung  
 Chevauchement

 Evenly distribute the first row of sheets and screw only the bottom row.  
 Verteilen Sie die erste Blechreihe gleichmäßig und schrauben Sie nur die unterste Reihe fest.  
 Répartir uniformément la première rangée de feuilles et ne visser que la rangée inférieure.

 Evenly distribute the second row of sheets and screw the remaining rows.

 Verteilen Sie die zweite Blechreihe gleichmäßig und verschrauben Sie die restlichen Reihen.

 Répartir uniformément la deuxième rangée de feuilles et visser les rangées restantes.

 Overlap  
 Überlappung  
 Chevauchement

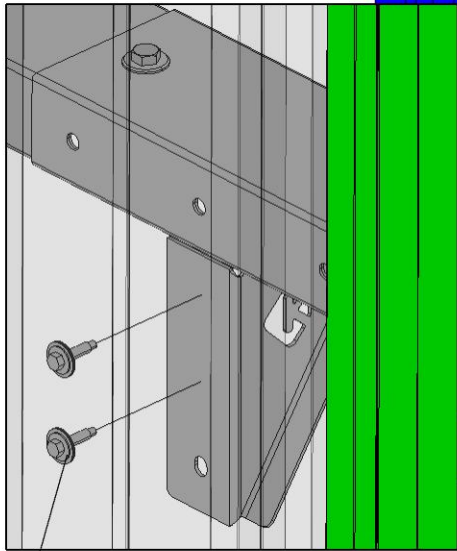

SC-Ar

K129  
7x

