

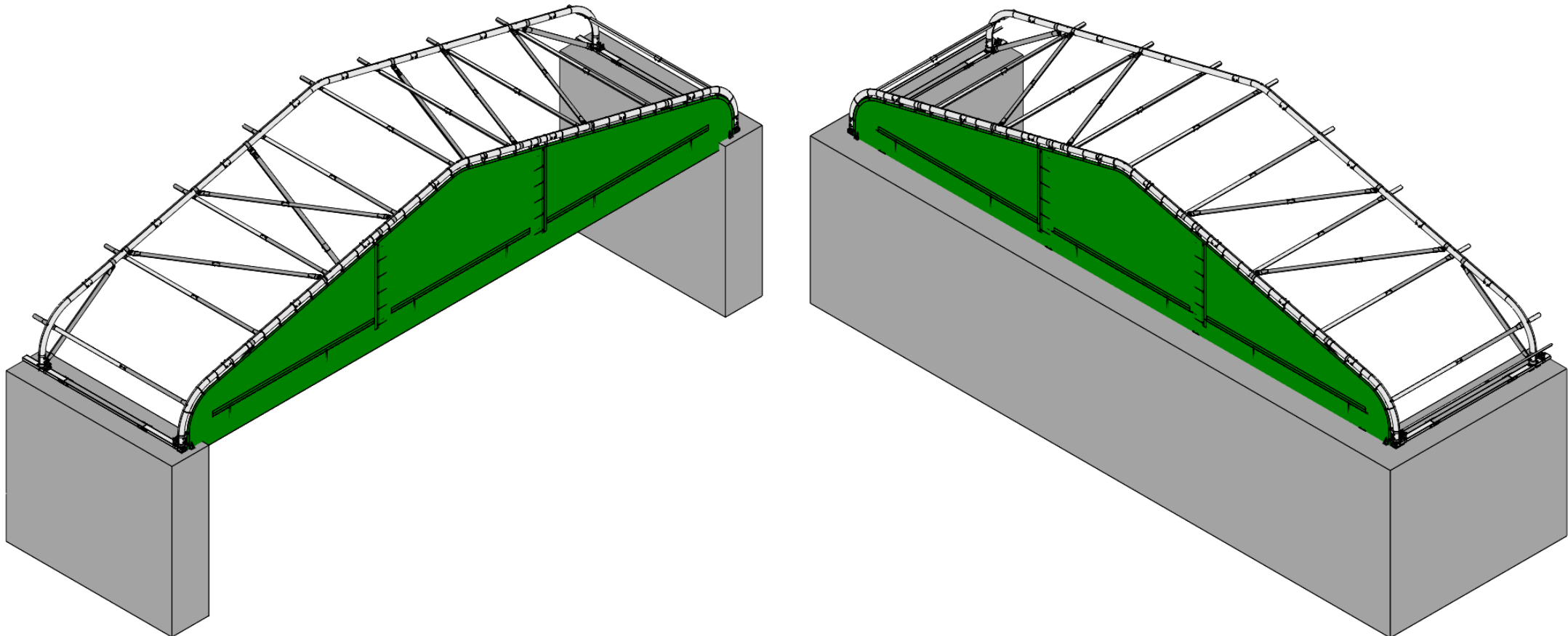

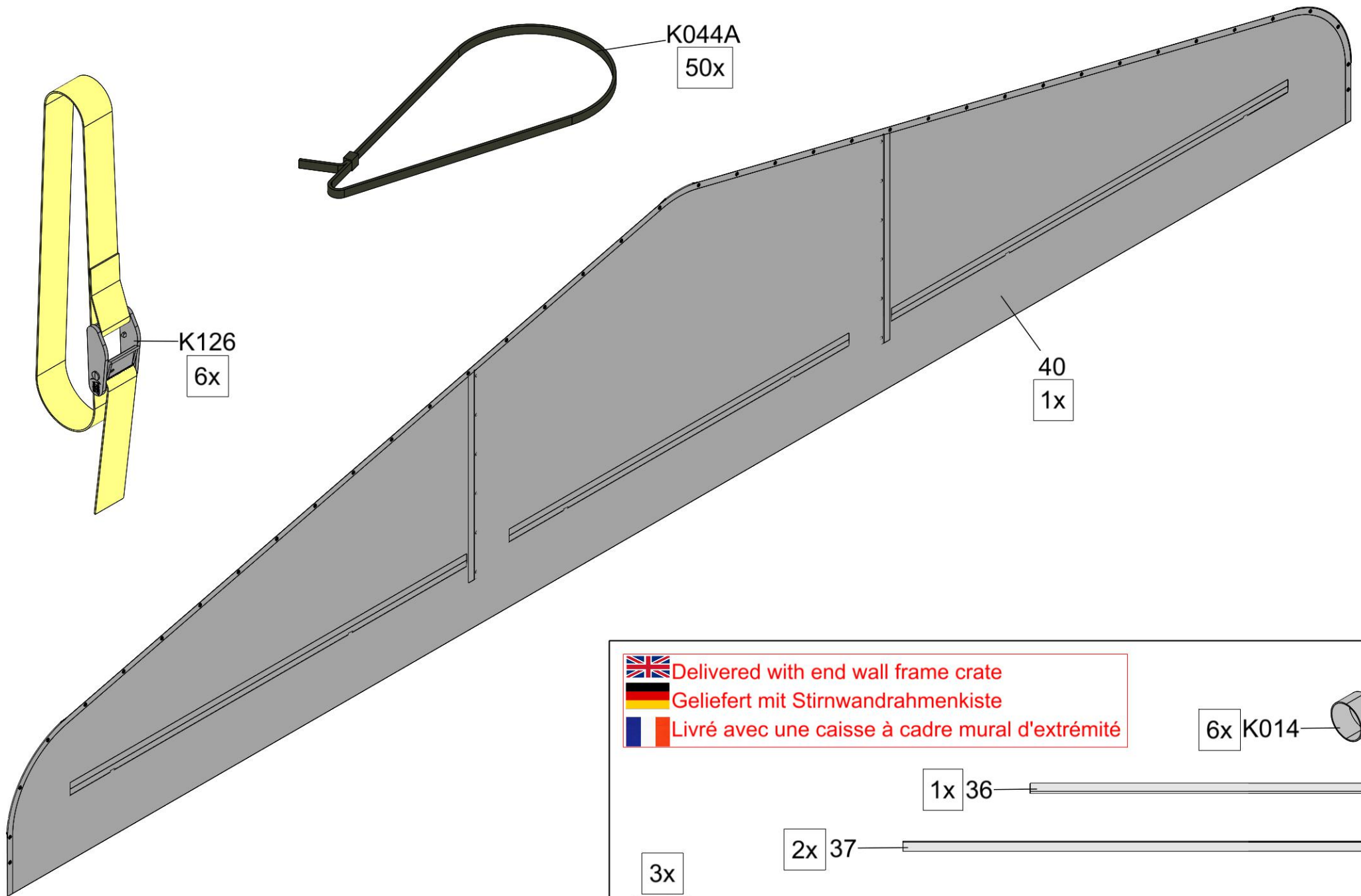

# KROFTMAN CT-S-HS-1200 & CT-S-H-1200

Assembly manual for suspended and unsuspended half end wall cover  
Montageanleitung für hängende und nicht hängende halbe Stirnwandplane  
Manuel de montage pour demi-couvre-mur suspendu et non suspendu







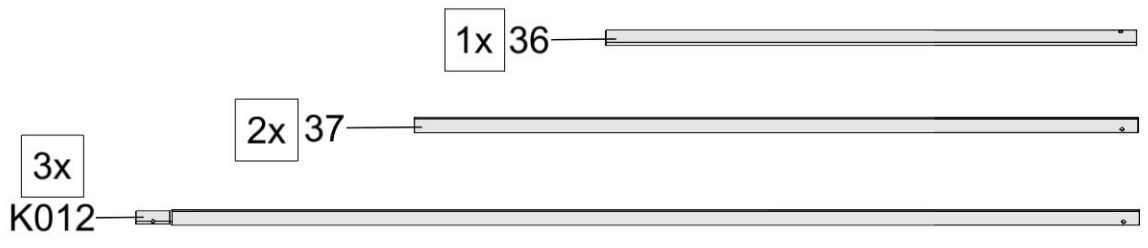
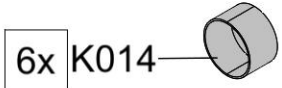

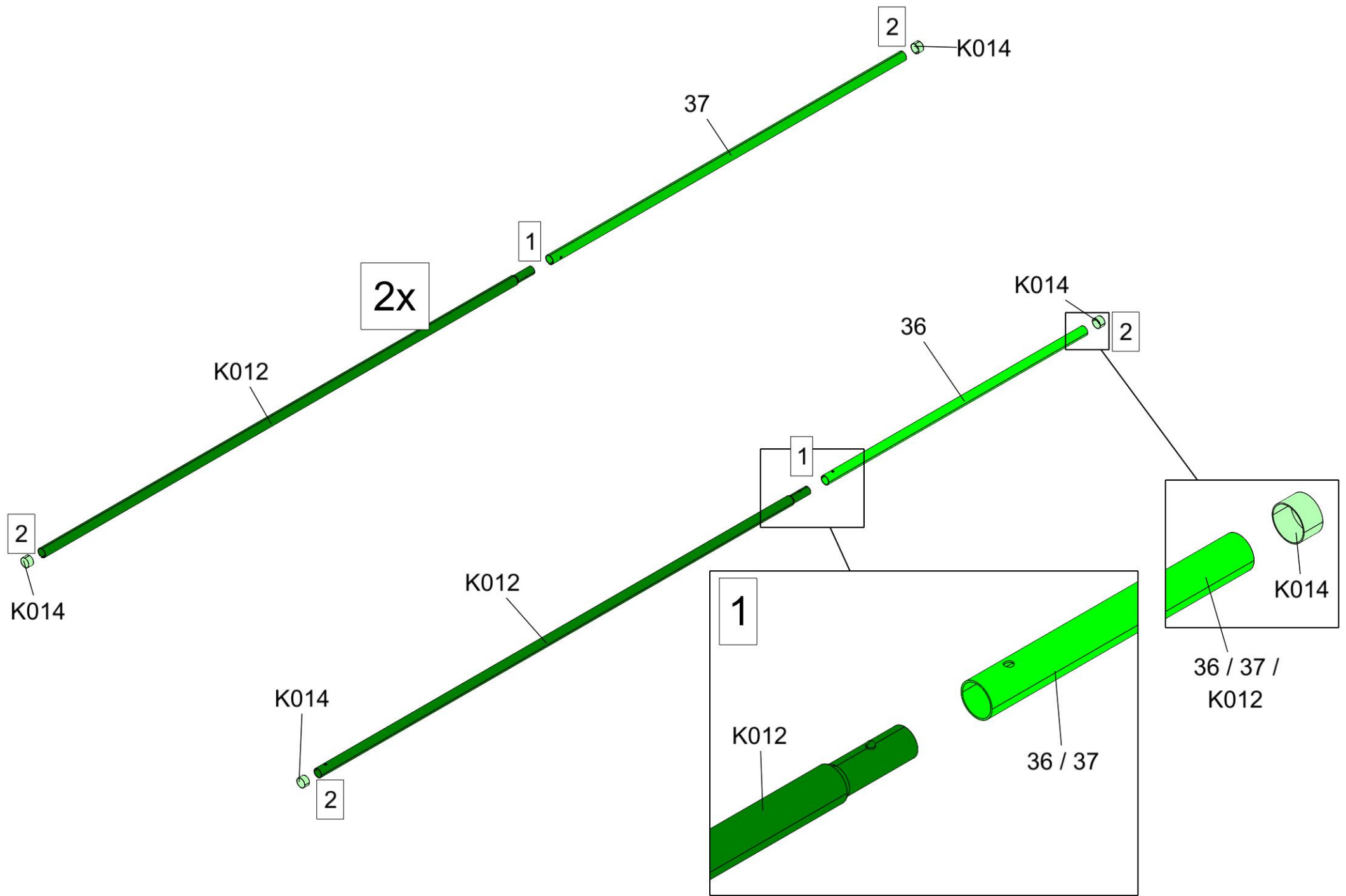

 Delivered with end wall frame crate  
 Geliefert mit Stirnwandrahmenkiste  
 Livré avec une caisse à cadre mural d'extrémité



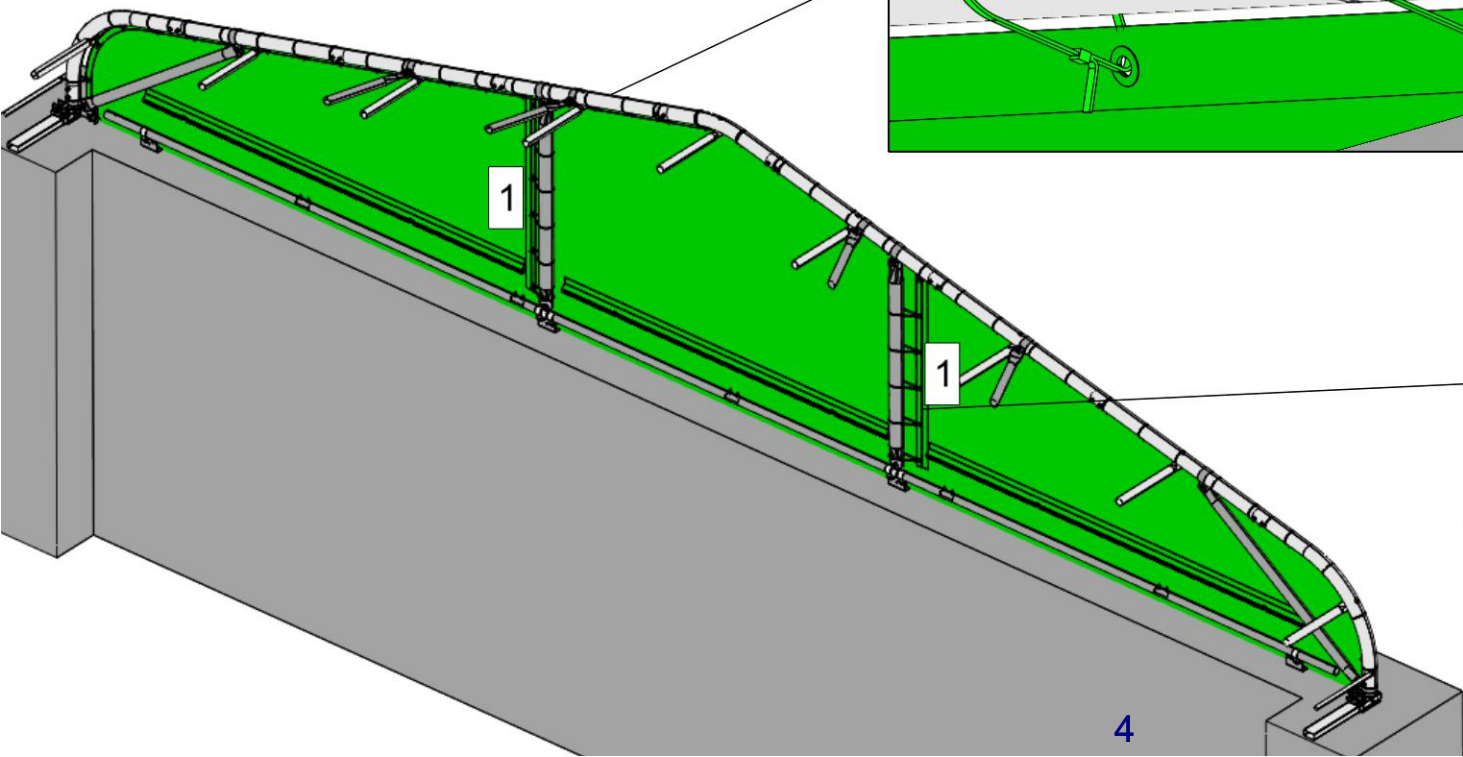
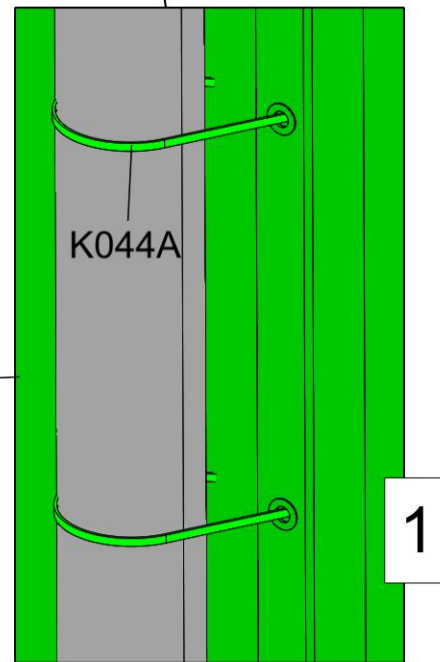
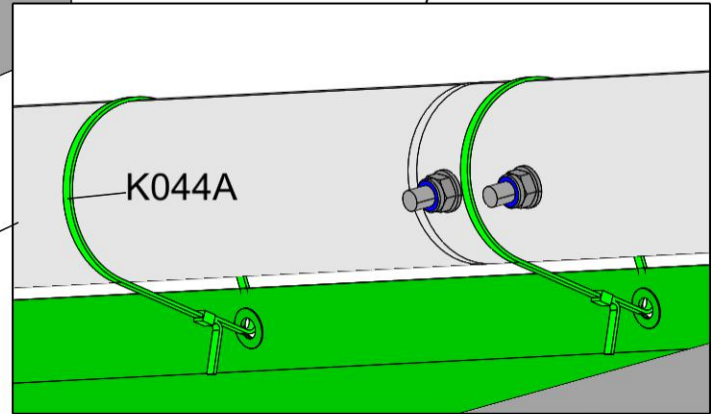
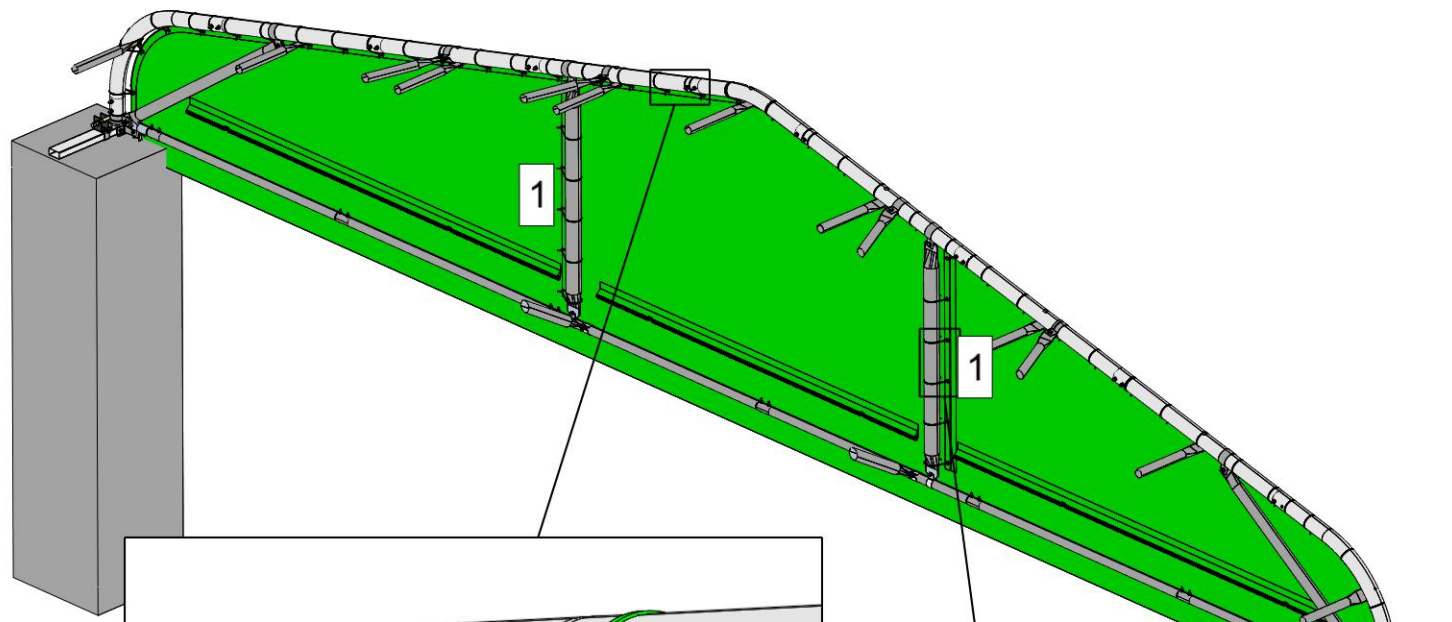

 Hoist the cover and secure it to the frame with tie wraps.  
 Heben Sie die Plane hoch und befestigen Sie sie mit Kabelbindern am Rahmen.  
 Hisser la couverture et la fixer au cadre à l'aide de colliers de serrage.



 Insert the tubes through cover's pockets  
 Führen Sie die Schläuche durch die Taschen des Deckels  
 Insérer les tubes dans les poches du couvercle

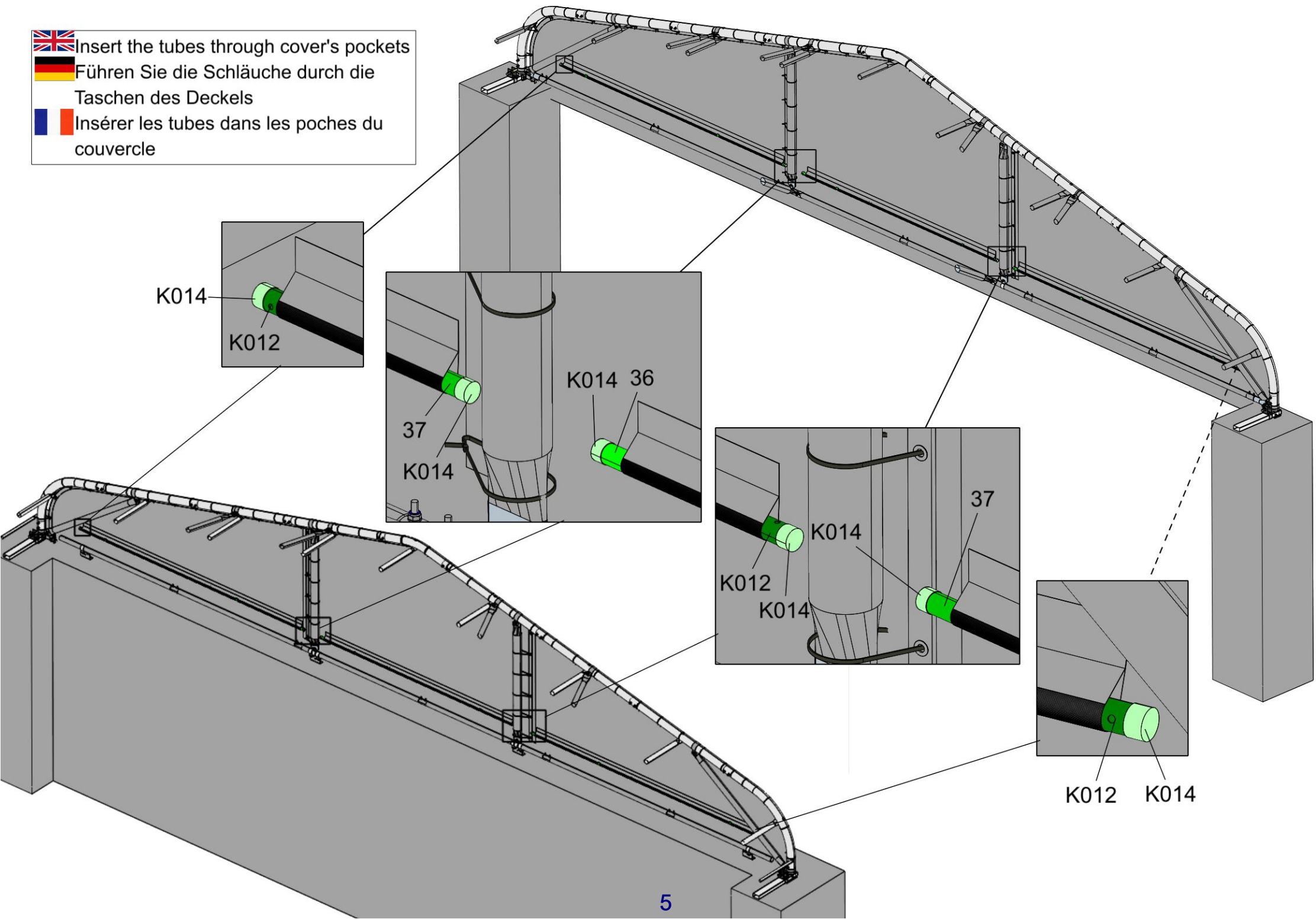

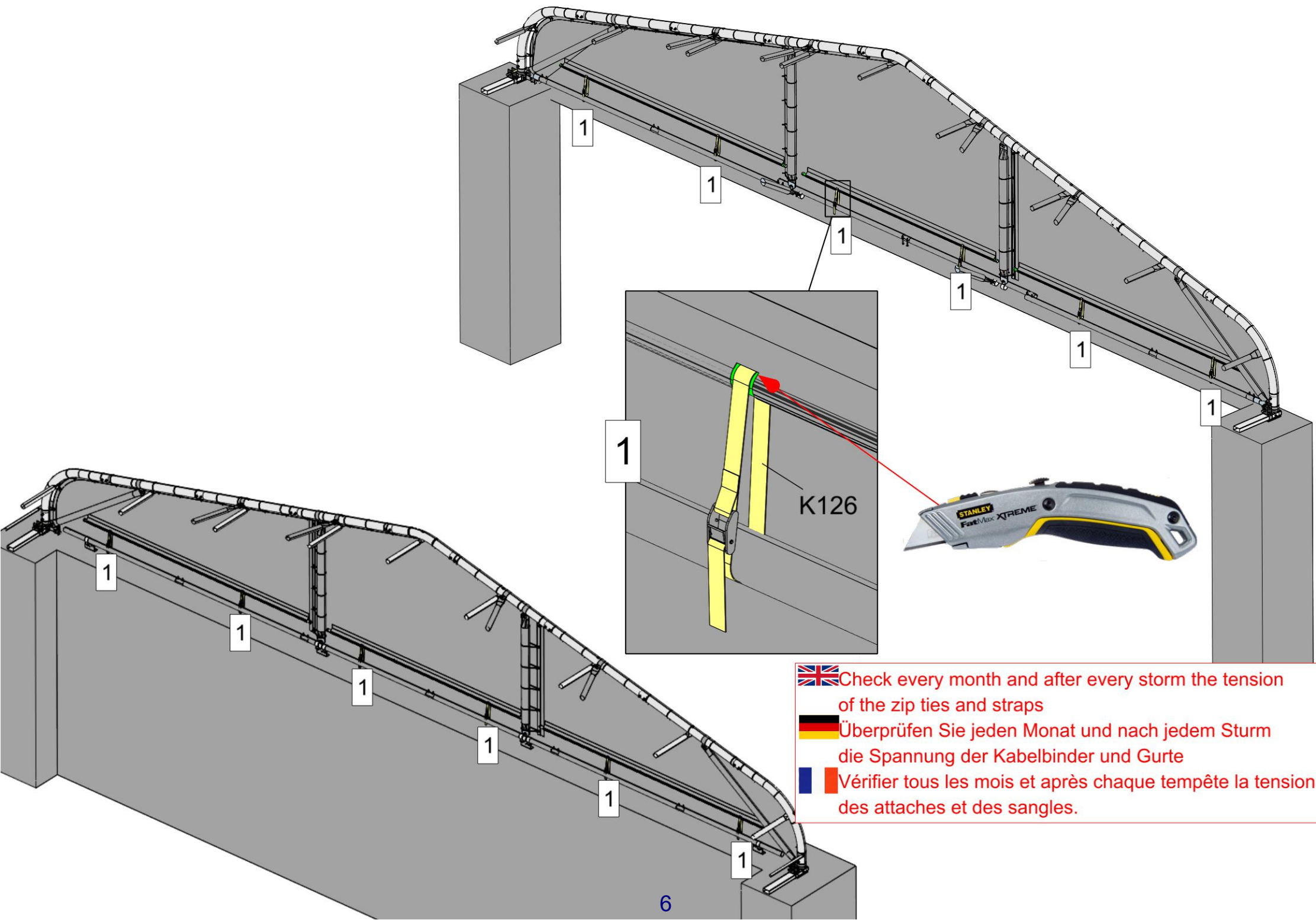

1

1

1

1

1

1

1

1

1



1

1

1

1

K126

 Check every month and after every storm the tension of the zip ties and straps  
 Überprüfen Sie jeden Monat und nach jedem Sturm die Spannung der Kabelbinder und Gurte  
 Vérifier tous les mois et après chaque tempête la tension des attaches et des sangles.